

**KENWOOD®**  
HI/FI STEREO COMPONENTS

# SERVICE MANUAL

## KR-720 (KR-720L) (KR-725)

An item of adjustment is written in three languages — English, French and German.

*Un article sur réglages est écrit en trois langues, Anglais, Français et Allemand.*

Ein Artikel der Abgleich wird auf drei Sprachen, Englische, Französisch und Deutsch geschrieben.

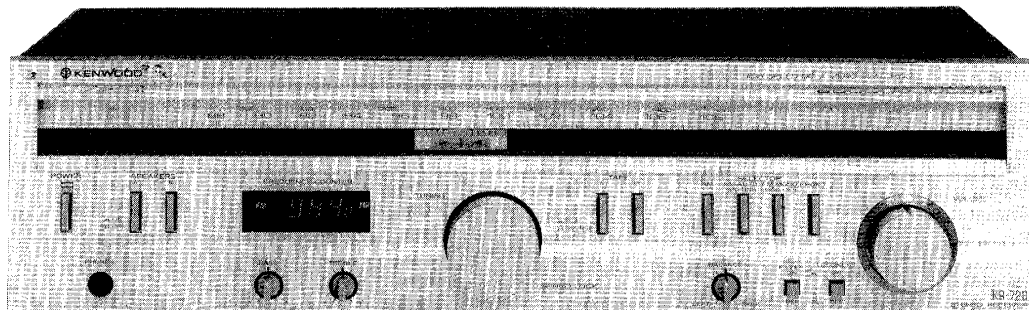

**HIGH SPEED DC/ZERO SWITCHING  
STEREO RECEIVER**

# CONTENTS

EXTERNAL VIEW (KR-720) .....	3
EXTERNAL VIEW (KR-720L) .....	4
INTERNAL VIEW (KR-720L) .....	5
DIAL CORD STRINGING .....	5
EXPLODED VIEW .....	6
BLOCK DIAGRAM .....	7
LEVEL DIAGRAM .....	7
ADJUSTMENT/REGLAGES/ABGLEICH .....	8
PC BOARD .....	16
SCHEMATIC DIAGRAM (KR-720) .....	17
SPECIFICATIONS (KR-720) .....	17
SCHEMATIC DIAGRAM (KR-720L) .....	18
SPECIFICATIONS (KR-720L) .....	18
PARTS LIST .....	19

**Note:**

Component and circuitry are subject to modification to insure best operation under differing local conditions. This manual is based on the U.S. (K) standard and provides information on regional circuit modification through use of alternate schematic diagrams, and information on regional component variations through use of parts list.

	Region	Code
KR-720	U.S.A. ....	K
	Canada .....	P
	PX .....	U
	Australia .....	X
	Europe and Scandinavia .....	E
	England .....	T
	Other Areas .....	M
	Audio Club .....	H
	PX (of Europe) .....	<b>UE</b>
	Europe and Scandinavia .....	<b>E</b>
KR-720L	England .....	<b>T</b>
	U.S.A. ....	<b>K</b>

**EXTERNAL VIEW (KR-720)**

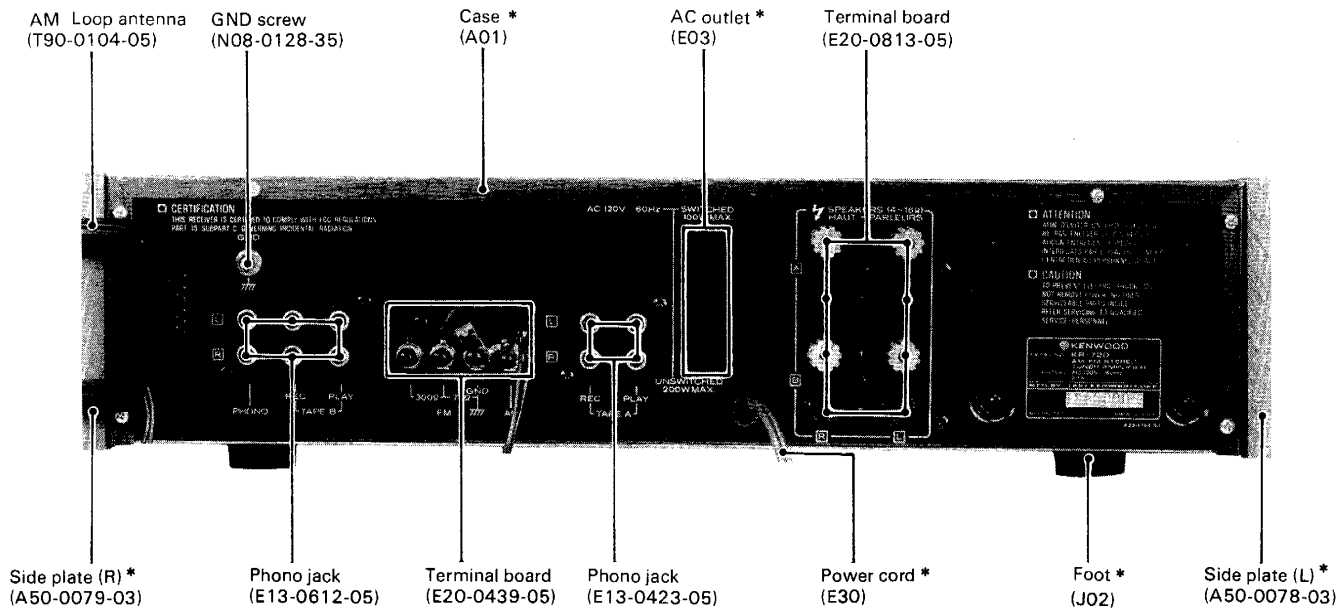
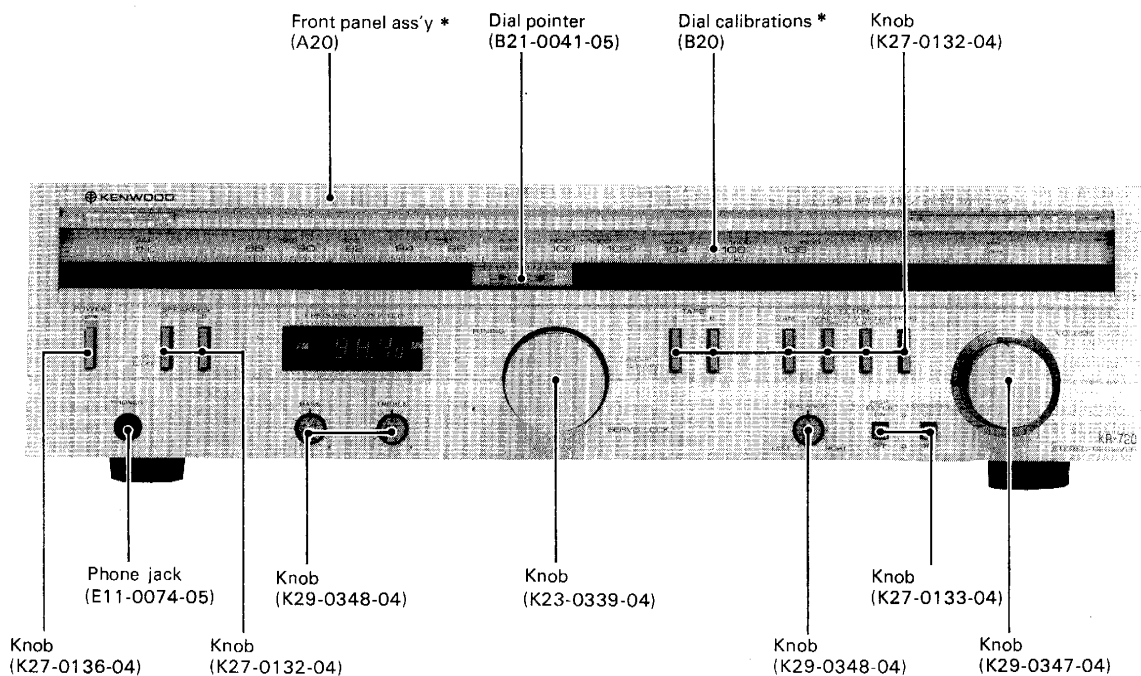

\* Refer to Parts List.

## EXTERNAL VIEW (KR-720L)

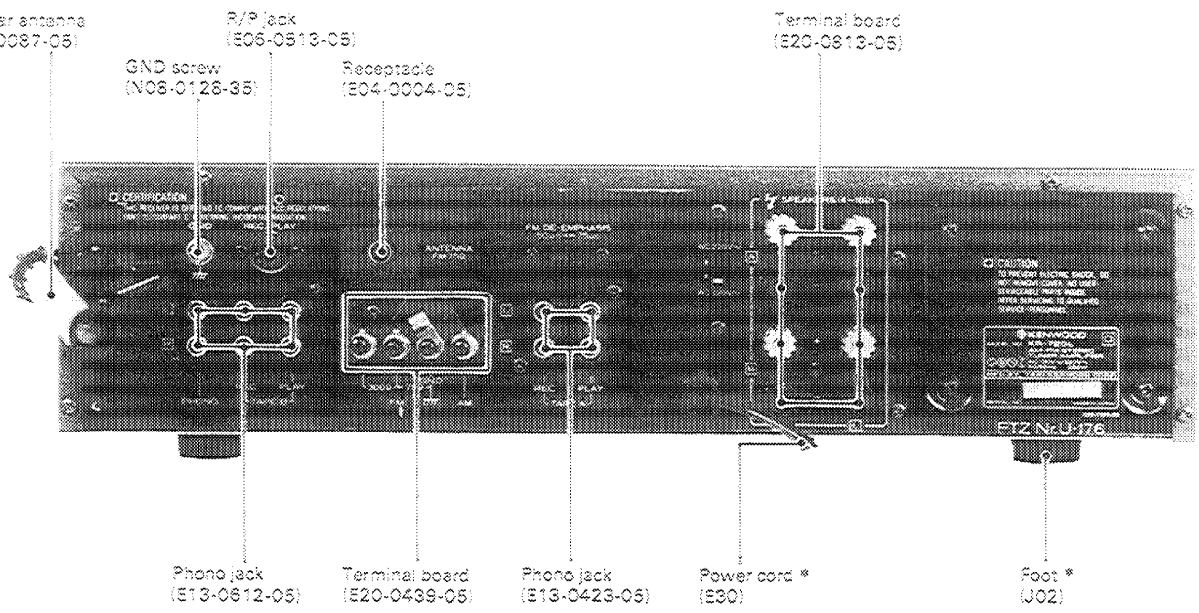
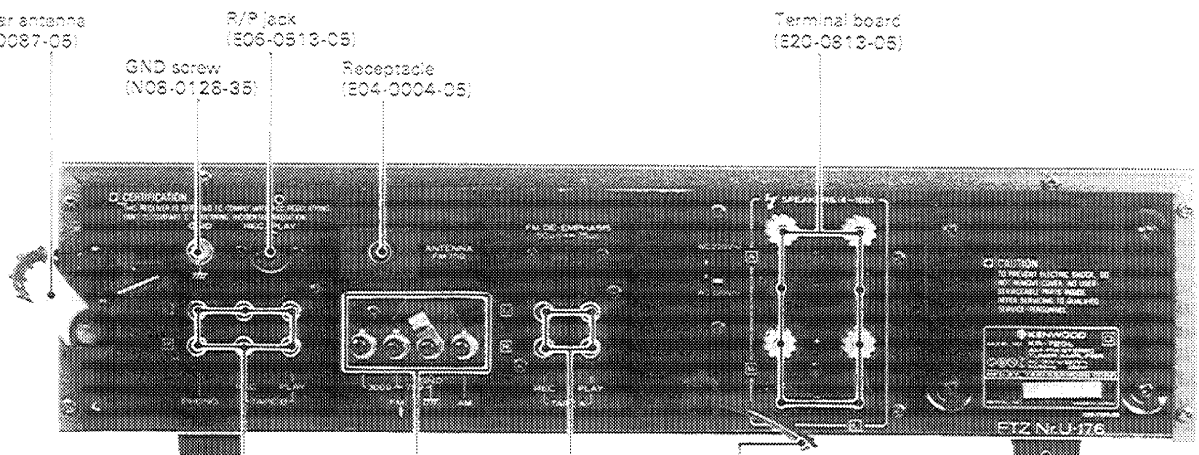
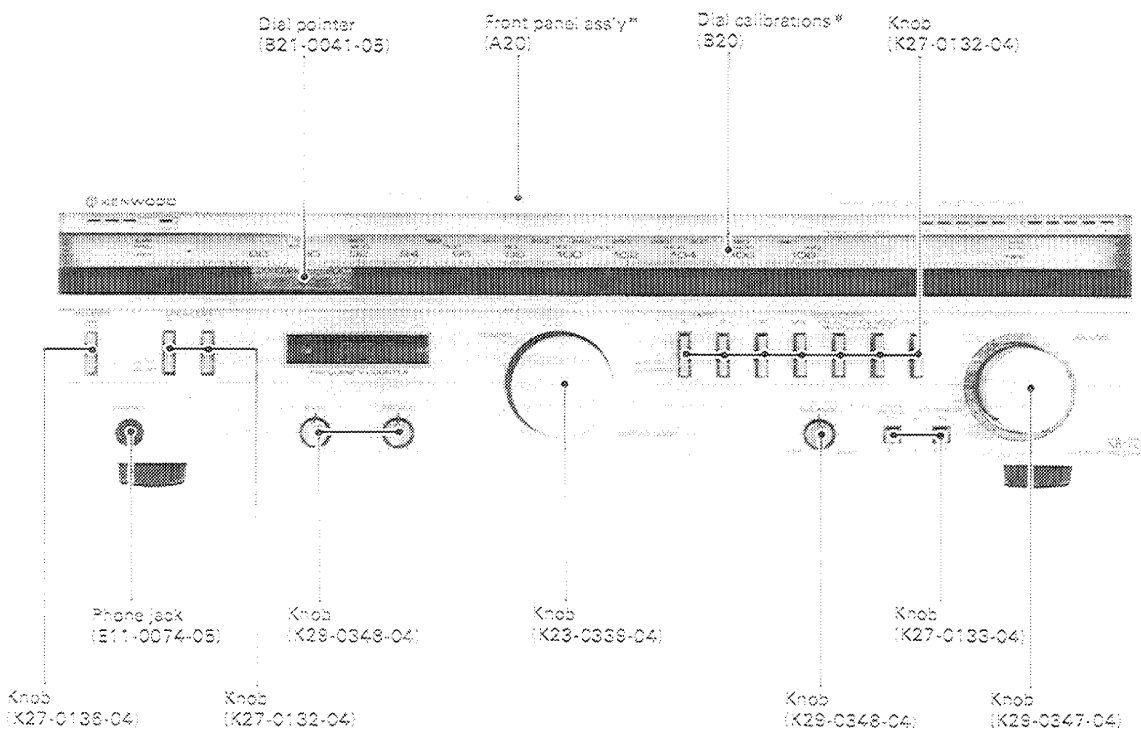
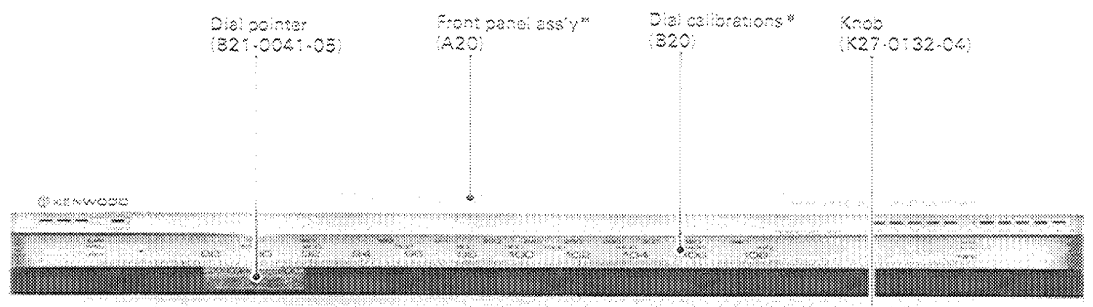

\* Refer to Parts List.

## INTERNAL VIEW (KR-720L)/DIAL CORD STRINGING

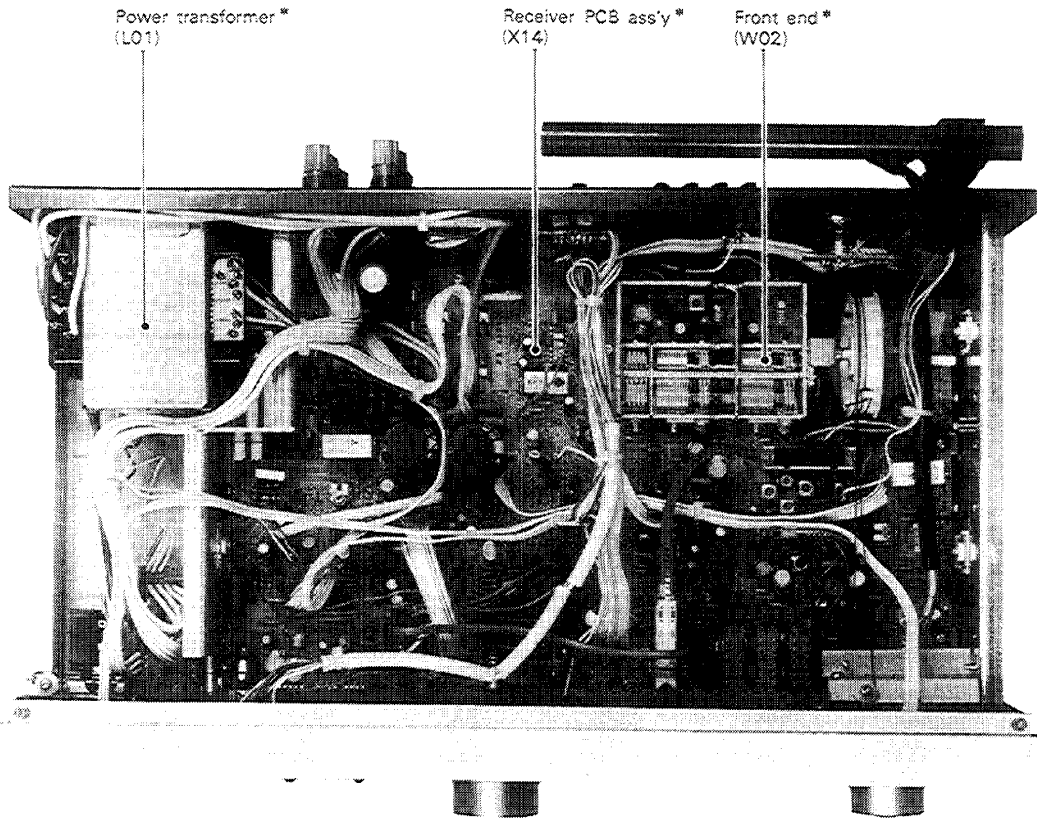

\* Refer to Parts List

### DIAL CORD STRINGING

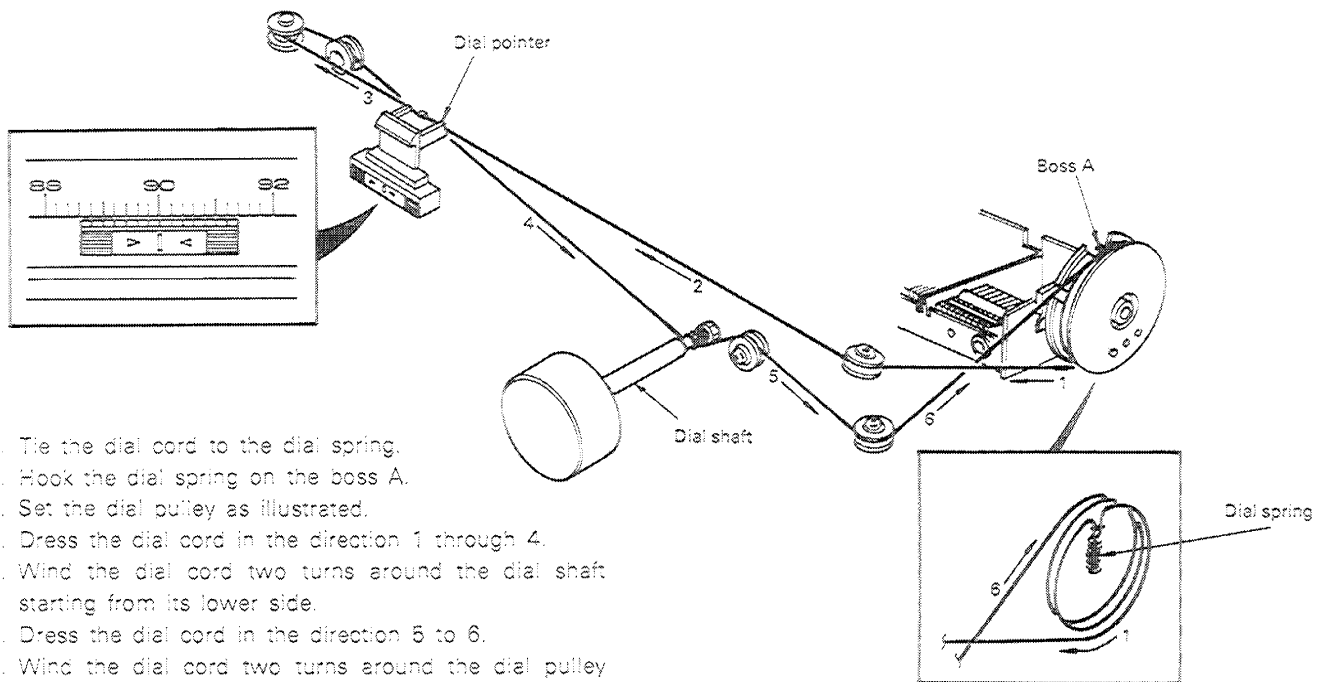

1. Tie the dial cord to the dial spring.
2. Hook the dial spring on the boss A.
3. Set the dial pulley as illustrated.
4. Dress the dial cord in the direction 1 through 4.
5. Wind the dial cord two turns around the dial shaft starting from its lower side.
6. Dress the dial cord in the direction 5 to 6.
7. Wind the dial cord two turns around the dial pulley starting from its upper side.
8. Tie the end of the dial cord to the dial spring.
9. Remove the dial spring from the boss A.
10. Receive a 90 MHz signal, and then mount the dial pointer at the 90 MHz position of the dial calibrations.

## EXPLODED VIEW

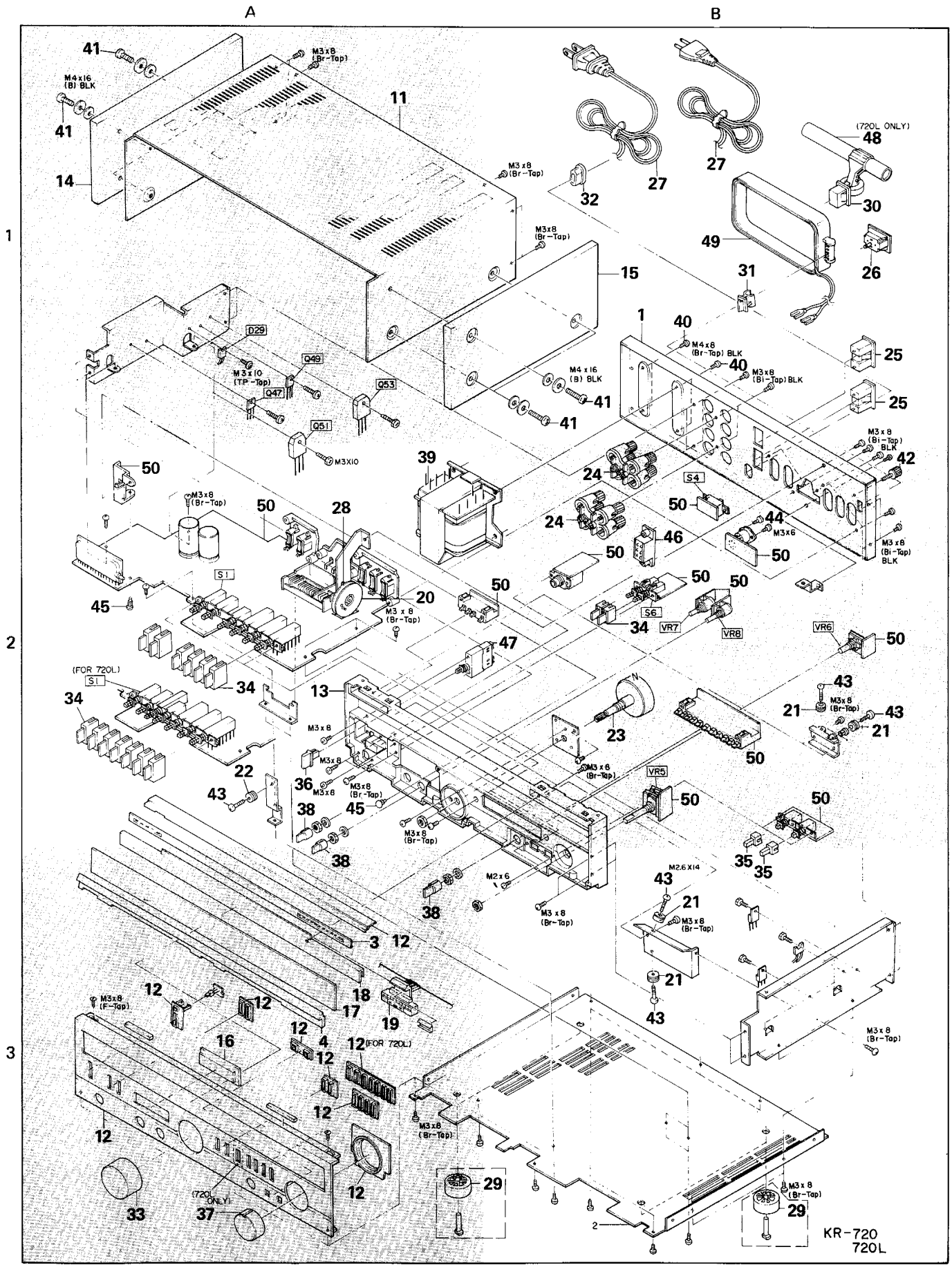

KR-720  
720L

## BLOCK DIAGRAM/LEVEL DIAGRAM

### BLOCK DIAGRAM

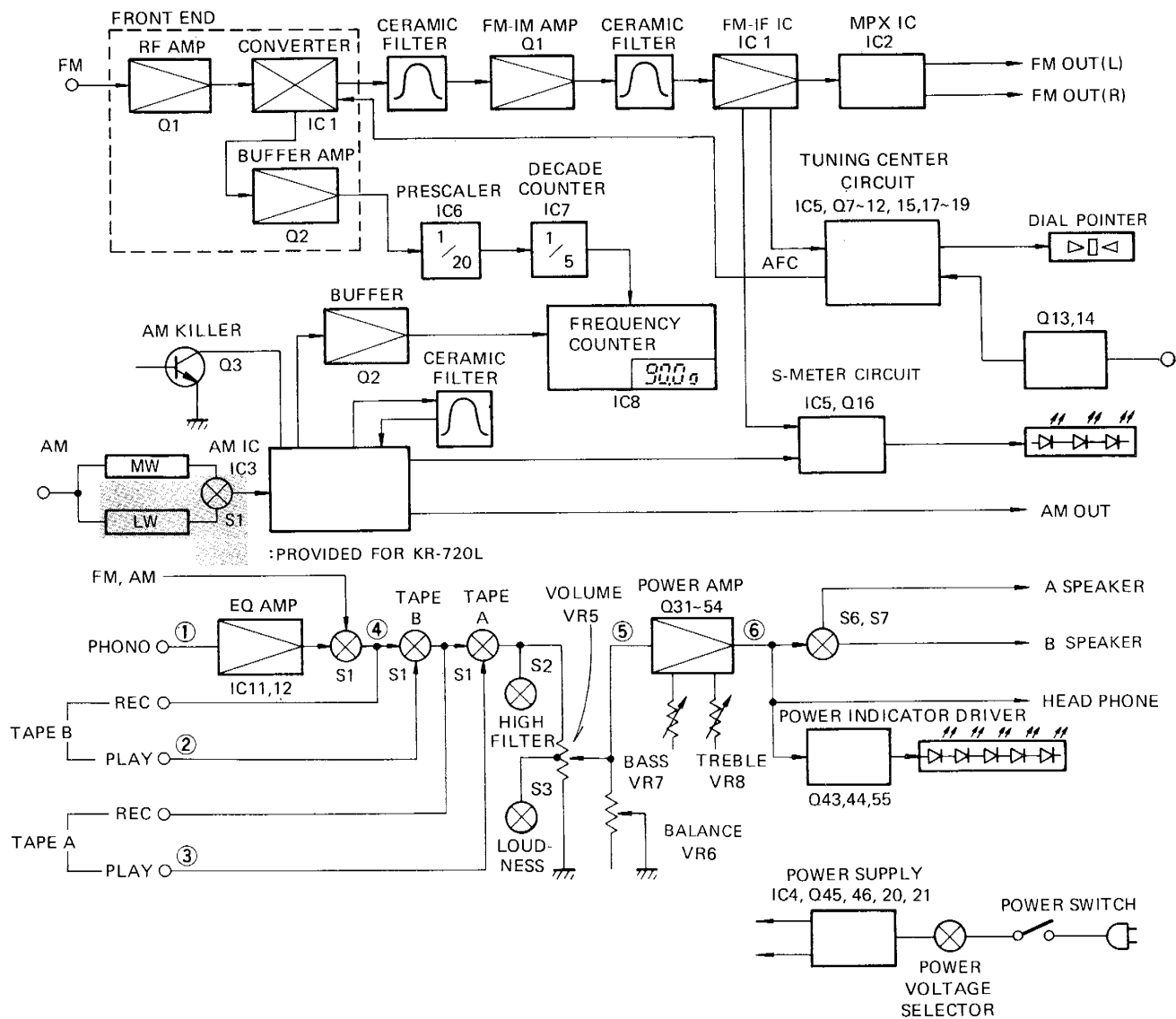

### LEVEL DIAGRAM

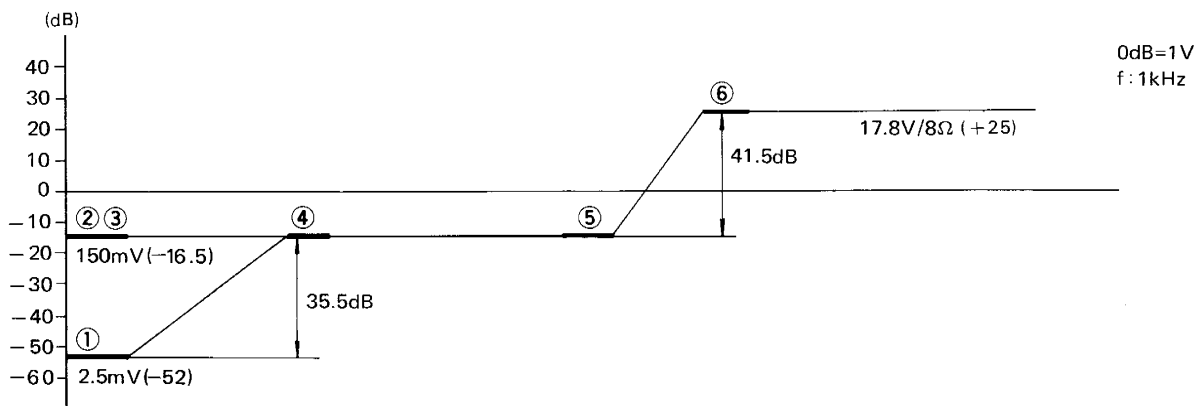

**ADJUSTMENT (AMP)/REGLAGES (AMPLI)/ABGLEICH (VERSTÄRKER)****OFFSET**

1. Set the SPEAKERS switch to A and the VOLUME to 0.
2. Connect a DC voltmeter to the SPEAKERS A terminals.
3. Adjust VR9 (VR10) for a 0V reading of the DC voltmeter.

**DECALAGE (OFFSET)**

1. Régler SPEAKERS interrupteur au A et VOLUME au 0.
2. Brancher le voltmètre de C.C. aux bornes de sortie (SPEAKERS A) + et -.
3. Régler VR9 (VR10) de façon à ce que le voltmètre de C.C. indique 0V.

**VERSCHIEBUNG**

1. Den Schalter SPEAKERS auf A und den VOLUME auf 0 einstellen.
2. Einen Gleichspannungsmesser an die Klemmen SPEAKERS A anschließen.
3. Den VR9 (VR10) so regulieren, daß die Gleichspannungsmesser-Ableseung 0V ist.

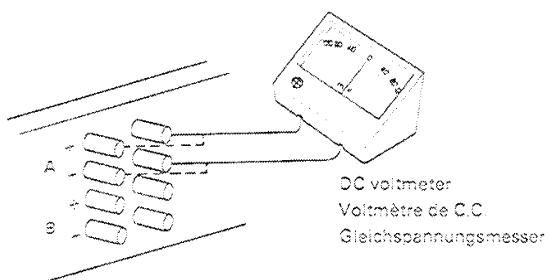
**IDLE CURRENT**

1. Set the VOLUME to 0.
2. Connect the DC voltmeter between the terminals of R263 (R264).
3. Adjust VR11 (VR12) for a 35.2 mV reading of the DC voltmeter.

**COURANT DE POLARISATION**

1. Régler VOLUME au 0.
2. Brancher le voltmètre de C.C. sur aux bornes de R263 (R264).
3. Régler VR11 (VR12) de façon à ce que le voltmètre de C.C. indique 35.2 mV.

**LEERLAUFSTROM**

1. Den VOLUME auf 0 einstellen.
2. Den Gleichspannungsmesser zwischen den Klemmen von R263 (R264).
3. Den VR11 (VR12) so regulieren, daß die Gleichspannungsmesser-Ableseung 35.2 mV ist.

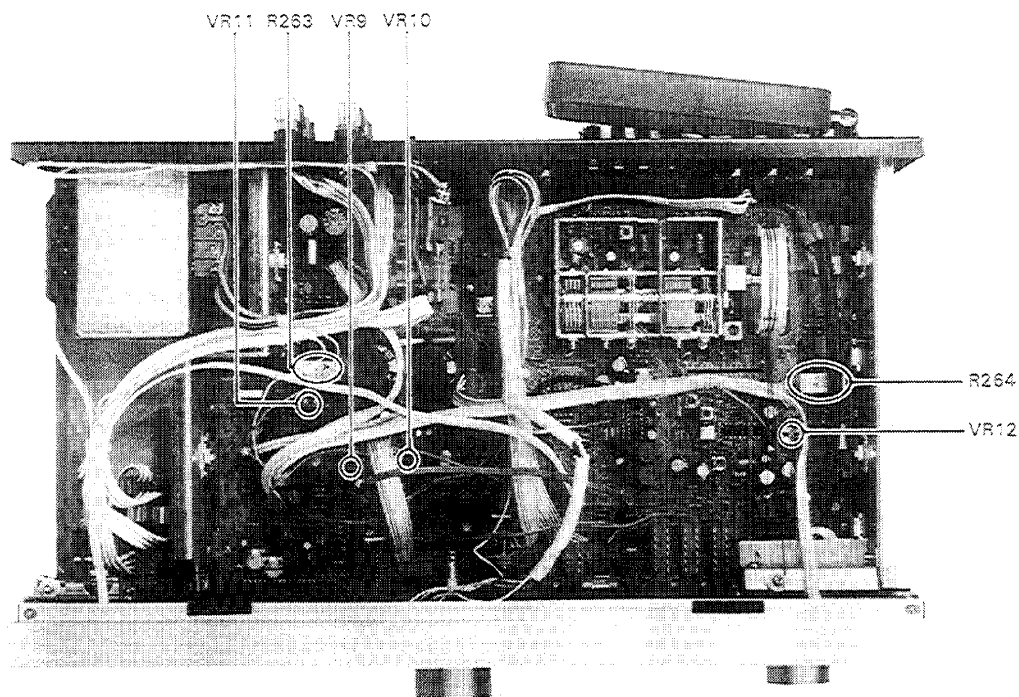
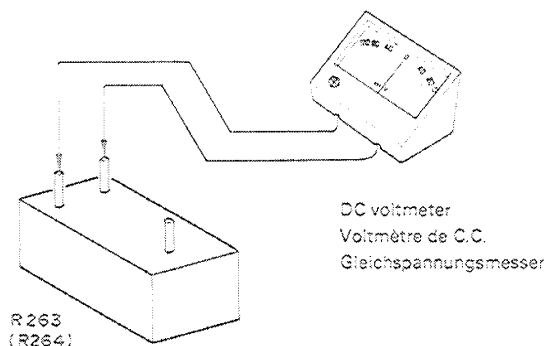



## ADJUSTMENT (TUNER)

NO.	ALIGNMENT	TEST EQUIPMENTS		RECEIVER SETTING	OUTPUT INDICATOR	ADJUSTMENT POINTS	REMARKS
		CONNECTION	SETTING				
<b>FM</b>							
1	DISCRIMINATOR (1)	Ⓐ	95 MHz 1 kHz, ±75 kHz Dev	FM-MONO 95 MHz	Ⓑ	—	* 1
2	DISCRIMINATOR (2)	ditto	95 MHz 1 kHz, ±75 kHz Dev 60 dB (ANT input)	ditto	* 2 R12	L1	0V
3	DISCRIMINATOR (3)	ditto	ditto	ditto	Ⓑ	L2	Minimum distortion
4	VCO	ditto	95 MHz 0 Dev 60 dB (ANT input)	FM-AUTO/MUTE 95 MHz	Frequency counter to the junction of R29 and VR2 via an AC voltmeter *3	VR2	76 kHz ±200 Hz
5	IFT	Ⓒ	95 MHz 1 kHz, ±68.25 kHz Dev SELECTOR: L or R PILOT: ON 60 dB (ANT input)	ditto	Ⓑ	T1 (Front end)	Minimum distortion
6	SEPARATION	ditto	ditto	ditto	ditto	VR1	* 4
<b>AM (KR-720)</b>							
①	IFT	Ⓓ	1 000 kHz 400 Hz, 30% Mod	AM 1 000 kHz	Ⓑ	L9	Maximum deflection
②	TRACKING (1)	ditto	600 kHz 400 Hz, 30% Mod	AM 600 kHz	ditto	L6, 7	ditto
③	TRACKING (2)	ditto	1 400 kHz 400 Hz, 30% Mod	AM 1 400 kHz	ditto	TC AM1,2 (Front end)	ditto
<b>AM (KR-720L)</b>							
①	IFT	Ⓓ	1 000 kHz 400 Hz, 30% Mod	MW 1 000 kHz	Ⓑ	L9	Maximum deflection
②	MW TRACKING (1)	ditto	600 kHz 400 Hz, 30% Mod	MW 600 kHz	ditto	Bar antenna (A) L7	ditto
③	MW TRACKING (2)	ditto	1 400 kHz 400 Hz, 30% Mod	MW 1 400 kHz	ditto	TC AM1, 2 (Front end)	ditto
④	LW TRACKING (1)	ditto	160 kHz 400 Hz, 30% Mod	LW 160 kHz	ditto	Bar antenna (B) L8	ditto
⑤	LW TRACKING (2)	ditto	340 kHz 400 Hz, 30% Mod	LW 340 kHz	ditto	TC1, 2	ditto
<b>FREQUENCY COUNTER * 5</b>							
I	FM	Ⓐ	89.10 MHz 0 Dev 20 dB (ANT input)	FM-MONO 89.1 MHz	Fluorescent indicator	VR3	89.1 MHz
II	AM	Ⓓ	1440.0 kHz 400 Hz, 30% Mod 30 dB (ANT input)	MW 1440 kHz	ditto	VR2	1440 kHz

\* 1 ~ 5 : See page 12.

## REGLAGES (TUNER)

N°.	ALIGNEMENT	APPAREILLAGE		REGLAGE DU AMPLI-TUNER	INDICATEUR DE SORTIE	POINTS DE REGLAGES	REMARQUES
		RACCORD-MENT	REGLAGE				
<b>SECTION MF</b>							
1	DISCRIMINATEUR (1)	Ⓐ	95 MHz 1 kHz, ±75 kHz Dév	FM-MONO 95 MHz	Ⓑ	—	* 1
2	DISCRIMINATEUR (2)	idem	95 MHz 1 kHz, ±75 kHz Dév 60 dB (Entrée ANT)	idem	* 2 R12	L1	0V
3	DISCRIMINATEUR (3)	idem	idem	idem	B	L2	Distorsion minimale
4	OSCILLATEUR 76 kHz	idem	95 MHz 0 Dév 60 dB (Entrée ANT)	FM-AUTO/MUTE 95 MHz	Relier un fréquencesmètre au plot R29 et VR2 par un voltmètre C.A. *3	VR2	76 kHz ±200 Hz
5	TFI	Ⓒ	95 MHz 1 kHz, ±68,25 kHz Dév SELECTION: L ou R Signal pilote (±6,75 kHz Dév) 60 dB (Entrée ANT)	idem	Ⓑ	T1 (Partie frontale)	Distorsion minimale
6	SEPARATION	idem	idem	idem	idem	VR1	* 4
<b>SECTION MA (KR-720)</b>							
①	TFI	Ⓓ	1 000 kHz 400 Hz, 30% Mod)	AM 1 000 kHz	Ⓑ	L9	Déviati on maximale
②	ALIGNEMENT	idem	600 kHz 400 Hz, 30% Mod	AM 600 kHz	idem	L6, 7	idem
③	ALIGNEMENT	idem	1 400 kHz 400 Hz, 30% Mod	AM 1 400 kHz	idem	TC AM1, 2	idem
<b>SECTION MA (KR-720L)</b>							
①	TFI	Ⓓ	1 000 kHz 400 Hz, 30% Mod	MW 1 000 kHz	Ⓑ	L9	Déviati on maximale
②	MW-ALIGNEMENT	idem	600 kHz 400 Hz, 30% Mod	MW 600 kHz	idem	Antenne MA (A), L7	idem
③	MW-ALIGNEMENT	idem	1 400 kHz 400 Hz, 30% Mod	MW 1 400 kHz	idem	TC AM1, 2 (Partie frontale)	idem
④	LW-ALIGNEMENT	idem	160 kHz 400 Hz, 30% Mod	LW 160 kHz	idem	Antenne MA (B), L8	idem
⑤	LW-ALIGNEMENT	idem	340 kHz 400 Hz, 30% Mod	LW 340 kHz	idem	TC1, 2	idem
<b>FREQUENCESMETRE *5</b>							
I	MF	Ⓐ	89.10 MHz 0 Dév 20 dB (Entrée ANT)	FM-MONO 89.1 MHz	Indicateur à fréquence	VR3	89.1 MHz
II	MA	Ⓓ	1440.0 kHz 400 Hz, 30% Mod 30 dB (Entrée ANT)	MW 1440 kHz	idem	VR4	1440 kHz

\*1 ~ 5 : Voir la page 12.

## ABGLEICH (EMPFÄNGER)

NR.	ABGLEICH	PRÜFEINRICHTUNG		STEU- GERÄT EINSEL- LUNG	AUSGANGS- ANZEIGE	EINSTELL- PUNKT	BEMER- KUNGEN
		ANSCHLÜSSE	EINSTELLUNG				
<b>UKW-EMPFANGSABTEILUNG</b>							
1	DISCRIMI- NATOR (1)	Ⓐ	95 MHz 1 kHz, ±75 kHz Hub	FM-MONO 95 MHz	Ⓑ	—	* 1
2	DISKRIMI- NATOR (2)	dito	95 MHz 1 kHz, ±75 kHz Hub 60 dB (Eingangssignalpegel)	dito	* 2 R12	L1	0V
3	DISKRIMI- NATOR (3)	dito	dito	dito	Ⓑ	L2	Minimaler Klirrfaktor
4	SPANNUNGS- GEREGELTER OSZILLATOR	dito	95 MHz 0 Hub 60 dB (Eingangssignalpegel)	FM- AUTO/MUTE 95 MHz	Frequenzzähler zum Kreuzungs- punkt von R29 und VR2 über einen Wechselspannungs- messer *3	VR2	76 kHz ±100
5	ZF-T	Ⓒ	95 MHz 1 kHz, ±68,25 kHz Hub Wähler: L oder R Pilotton: (±6,75 kHz Hub) 60 dB (Eingangssignalpegel)	dito	Ⓑ	T1 (Frontende)	Minimaler Klirrfaktor
6	STEREO KANAL TRENNUNG	dito	dito	dito	dito	VR1	* 4
<b>MW-EMPFANGS ABTEILUNG (KR-720)</b>							
①	ZF-T	Ⓓ	1 000 kHz 400 Hz, 30% Mod	AM 1 000 kHz	Ⓑ	L9	Marimaler Ausschlag
②	EMPFANGS- BEREICH (1)	dito	600 kHz 400 Hz, 30% Mod	AM 600 kHz	dito	L6, 7	dito
③	EMPFANGS- BEREICH (2)	dito	1 400 kHz 400 Hz, 30% Mod	AM 1 400 kHz	dito	TC AM1, 2	dito
<b>MW UND LW - EMPFANGSABTEILUNG (KR-720L)</b>							
①	ZF-T	Ⓓ	1 000 kHz 400 Hz, 30% Mod	MW 1 000 kHz	Ⓑ	L9	Maximaler Ausschlog
②	MW- EMPFANGS- BEREICH (1)	dito	600 kHz 400 Hz, 30% Mod	MW 600 kHz	dito	Ferritantenna (A) L7	dito
③	MW- EMPFANGS- BEREICH (2)	dito	1 400 kHz 400 Hz, 30% Mod	MW 1 400 kHz	dito	TC AM1, 2 (Frontende)	dito
④	LW- EMPFANGS- BEREICH (1)	dito	160 kHz 400 Hz, 30% Mod	LW 160 kHz	dito	Ferritantenna (B) L8	dito
⑤	LW- EMPFANGS- BEREICH (2)	dito	340 kHz 400 Hz, 30% Mod	LW 340 kHz	dito	TC1, 2	dito
<b>FREQUENZZÄHLER * 5</b>							
I	UKW	Ⓐ	89.10 MHz 0 Hub 20 dB (Eingangssignalpegel)	FM-MONO 89.1 MHz	Frequenz- indikator	VR3	89.1 MHz
II	MW	Ⓓ	1440 kHz 400 Hz, 30% Mod 30 dB (Eingangssignalpegel)	MW (AM) 1440.0 kHz	dito	VR4	1440 kHz

\*1~5 : Sehen den page 12.

## ADJUSTMENT (TUNER)/REGLAGES (TUNER)/ABGLEICH (EMPFÄNGER)

**\* 1**

Adjust the tuning knob so that the same amount of noise is observed at the top and bottom of the output waveform with a weak signal.

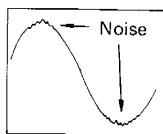

**\* 2**

Connect the DC voltmeter across R12.

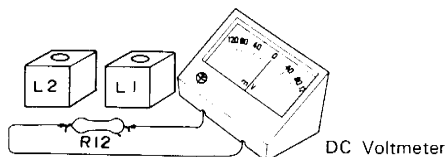

**\* 3**

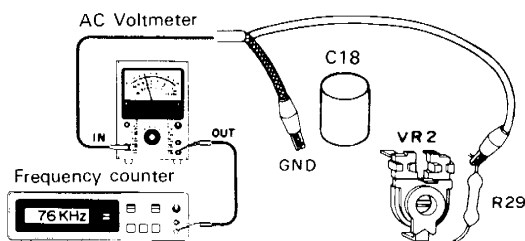

### \* 4 Minimum output

A compromise adjustment may be required if left-to-right and right-to-left separations are unequal.

**\* 5**

Fine adjustment is achieved as follows.

Apply +4.5V to the 12 pin of IC8. If the indicated frequency is incorrect, a digit of the indicator flickers (Refer to the figure).

89.10

Flickers in FM mode.

1440

Flickers in AM mode.

Adjust VR3 (FM) or VR4 (AM) so that the indicator stops flickering and shows the correct frequency.

### \* 6 FM fronted

The FM front end section is completely adjusted in the factory and further adjustment is not necessary. When the FM front end section cannot be repaired by replacing semiconductors, replace the FM front end PCB ass'y and do the following.

- (1) Set FM-SG to 90 MHz, 1 kHz Mod,  $\pm 75$  kHz Dev, 60 dB and connect it to the antenna terminal of the receiver.
- (2) Receive the FM-SG signal.
- (3) Fix the dial pointer at 90 MHz.

**\* 1**

Ajuster le bouton d'accord de façon que la même quantité de bruit puisse être observé au sommet et en bas de la forme d'onde de sortie sous des conditions d'alimentation de signal faible.

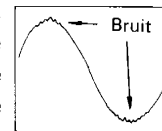

**\* 2**

Relier un voltmètre de C.C. sur R12.

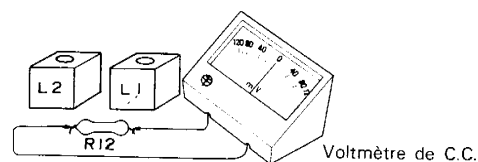

**\* 3**

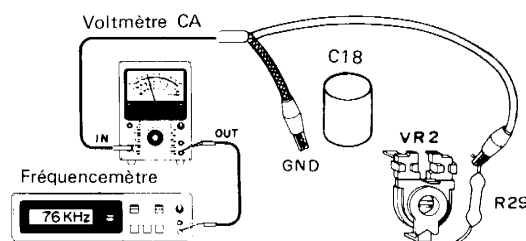

### \* 4 Sortie minimale

Si la sortie la droite de diaphonie et la gauche ne sont pas même régler le potentiomètre ajustable pour que la tension de sortie est même.

**\* 5**

Le réglage précis peut être effectué comme suit. Appliquer +4,5V à la fiche 12 de IC8. Si la fréquence indiquée n'est pas exacte, un chiffre de l'affichage papillote (Voir l'illustration).

89.10

Papillotements  
en mode MF.

1440

Papillotements  
en mode MA.

Régler VR3 (MF) ou VR4 (MA) pour éliminer les papillotements et jusqu'à ce que la fréquence exacte soit affichée.

**\* 6**

Si la partie frontale FM ne peut pas être réparée en remplaçant les semi-conducteurs PCB de la partie frontale et effectuer les opérations suivantes:

- (1) Régler FM-SG à 90 MHz, 1 kHz Mod,  $\pm 75$  kHz, 60 dB et le connecter à la borne d'antenne du récepteur.
- (2) Recevoir le signal FM-SG.
- (3) Fixer l'aiguille du cadran à 90 MHz.

## ADJUSTMENT (TUNER)/REGLAGES (TUNER)/ABGLEICH (EMPFÄNGER)

**\* 1**

Den Abstimmknopf so einstellen, daß an der oberen und unteren Grenze der Ausgangswellenform bei schwachem Signal dasselbe Geräusch auftritt.

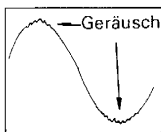

**\* 2**

Einen Gleichspannungsmesser über R12 anschließen.

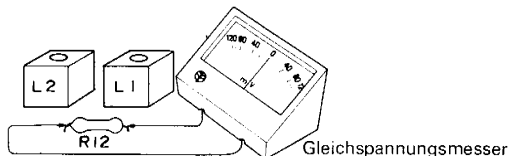

**\* 3**

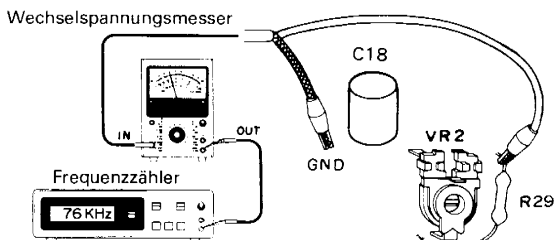

**\* 4 Minimaler Ausschlag**

Wenn dem Übersprechanteil des linken Kanals in den rechten Kanal und dem Übersprechanteil des rechten Kanals in den linken Kanal ungleich sind, eine kompromißabgleichung wird gefordert.

**\* 5**

Die genaue Einstellung wie folgt Vornehmen. +4,5V an Buchse 12 Vou IC8 anlegen. Falls die ausgegebene Frequenz nicht richtig ist, flickert eine Zahl der Darstellung (siehe Abbildung).

89.10

Flickern bei UKW-Empfang.

1440

Flickern bei MW-Empfang.

VR3 (UKW) oder VR4 (MW) so einstellen, daß das Flickern aufhört und bis die richtige Frequenz dargestellt ist.

**\* 6 UKW-Frontende**

Das UKW-Frontende wird bereits im Werk vollständig eingestellt. Weitere Einstellung ist daher nicht nötig.

Wenn das UKW-Frontende durch Auswechseln der Halbleiter nicht repariert werden kann, ist die Leiterplatte des Frontendes auszuwechseln und folgende Einstellung vorzunehmen:

- (1) Den UKW-Signalgenerator auf 90 MHz, 1 kHz Modulation  $\pm 75$  kHz Hub, und 60 dB einstellen und mit der Antennenklemme des Steuergeräts verbinden.
- (2) Den Steuergeräts so einstellen, daß das Meßsendersignal empfangen wird, während der Skalenzeiger auf 90 MHz zeigt.

### TEST INSTRUMENT

Oscilloscope .....  
 AM signal generator .....  
 FM signal generator .....  
 Audio generator .....  
 AC voltmeter .....  
 FM multiplex generator .....  
 Frequency counter .....  
 DC voltmeter .....  
 Distortion méter .....  
 Dummy antenna .....

### APPAREILLAGE

Oscilloscope .....  
 Générateur MA .....  
 Générateur MF .....  
 Générateur audio fréquences .....  
 Voltmètre CA .....  
 Générateur multiplex stéréo .....  
 Fréquencemètre .....  
 Voltmètre CC .....  
 Distorsiomètre .....  
 Antenna fictive .....

### PRÜFINSTRUMENTE

Oszilloskop ..... SCOPE  
 MW-Signalgenerator ..... AM-SG  
 UKW-Signalgenerator ..... FM-SG  
 NF-Signalgenerator ..... AG  
 Wechselspannungsmesser .....  
 UKW-Multiplexgenerator ..... FM-MPX  
 Frequenzzähler .....  
 Gleichspannungsmesser .....  
 Klirrfaktormesser .....  
 Antennennachbildung .....

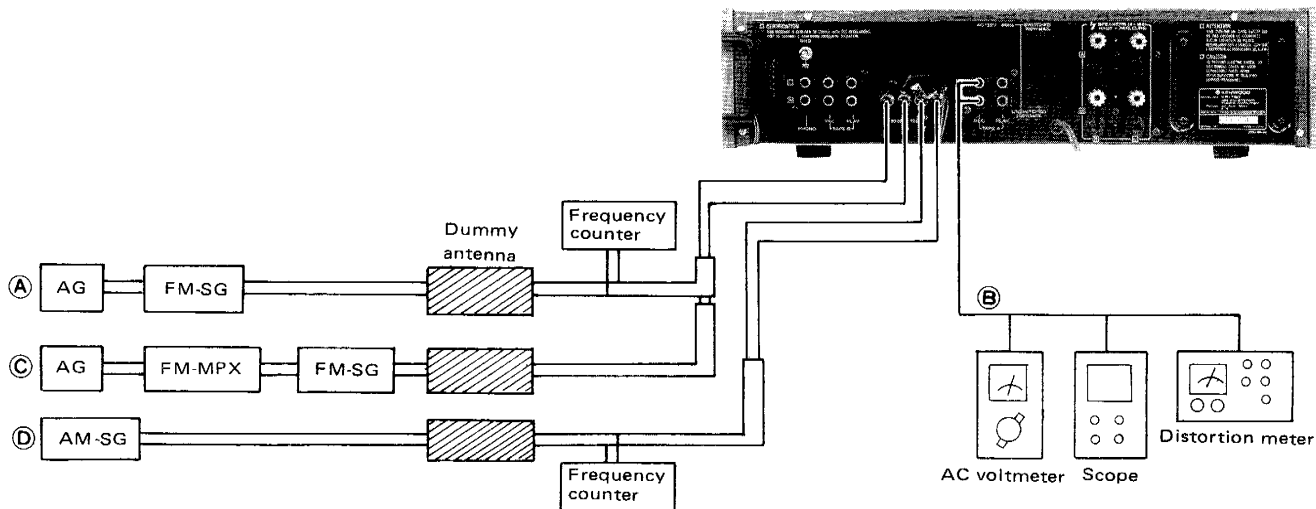

## ADJUSTMENT (TUNER)/REGLAGES (TUNER)/ABGLEICH (EMPFÄNGER)

KR-720

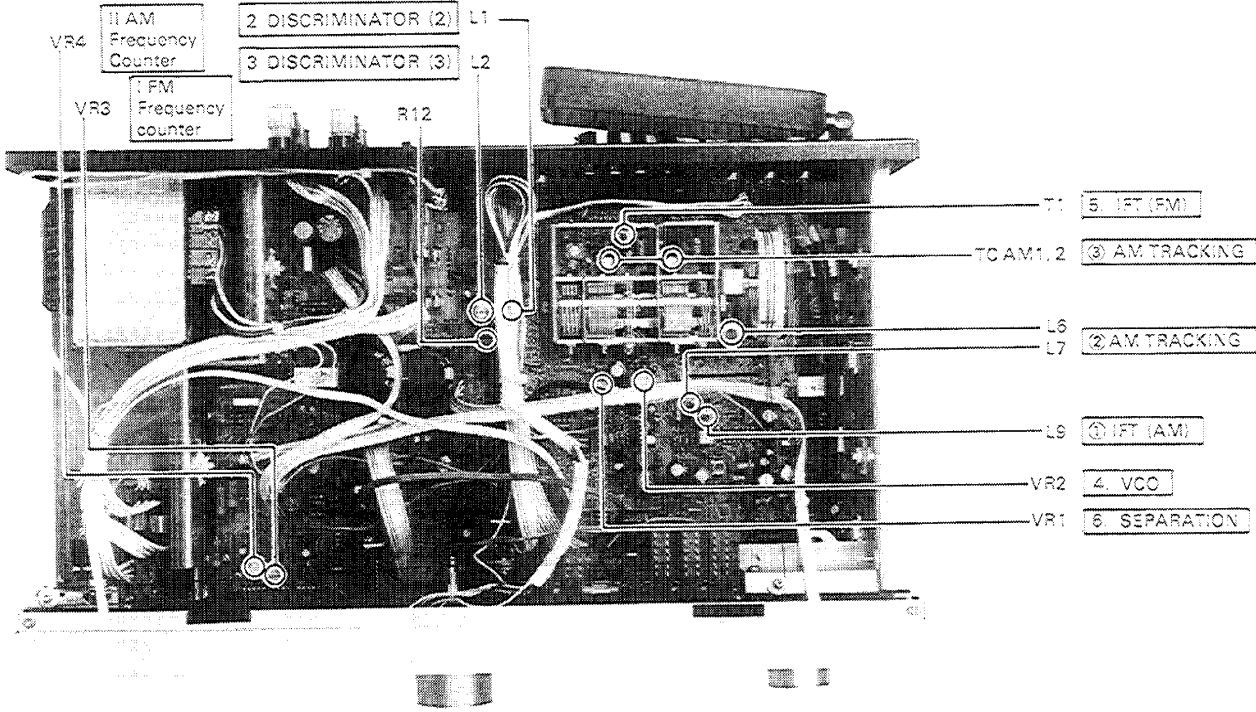

KR-720L

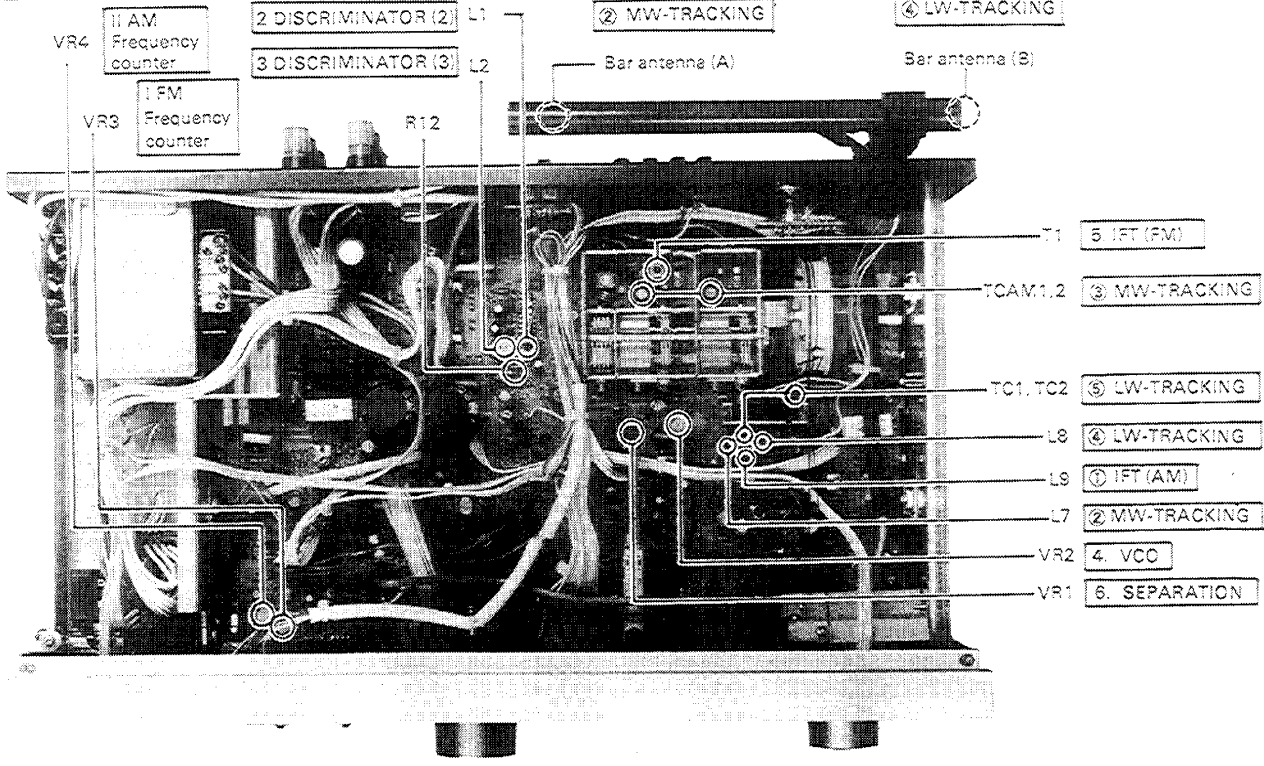

PC BOARD

RECEIVER (X14-115) Component side view

■ : Modifications for KR-720L

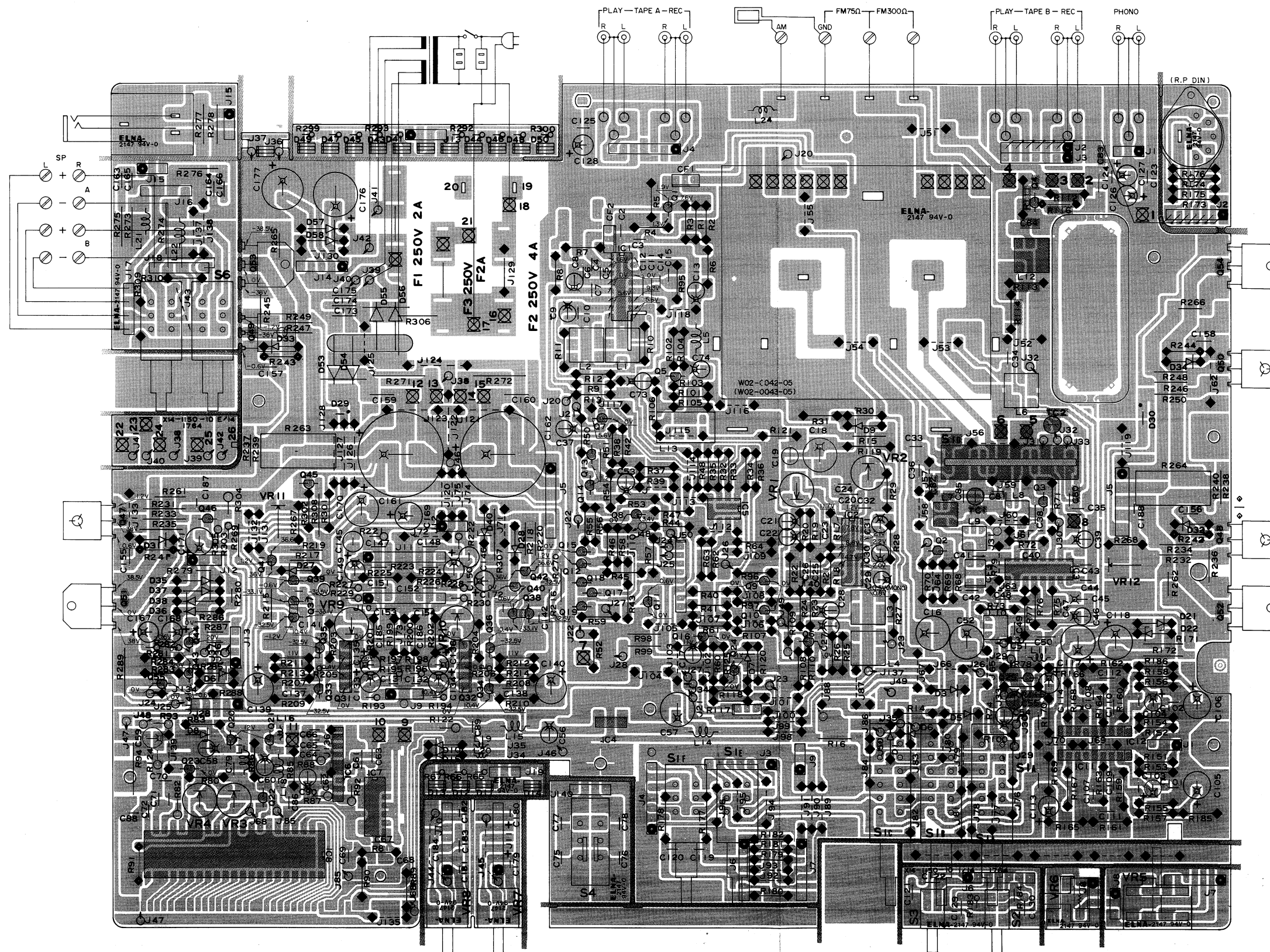

\*Refer to the schematic diagram for the values of resistors and capacitors.

IC1	HA1137W
IC3	HA1197
IC2	HA1196
IC4	μPC78M12H
IC5	AN6552
IC6	AN6821
IC7	SN74LS90N
IC8	LC7258
IC9	TA7322P
Q1	2SC1923
Q2,3,5,6,8,9,11,12,	
14~22,45,46	2SC945
Q10,13,33~36	2SA733
Q4,7	2SK163
Q31,32	2SA979
Q37,38	2SC1845 (1) (E,F)
Q39,40,43,44	2SC1845 (F)
Q41,42	2SA992 (F,E)
Q47,48	2SC2590 (Q,R)
Q49,50	2SA1110
Q51,52	2SA1102 (O,Y)
Q53,54	2SC2577 (O,Y)

A B C D E F G H I

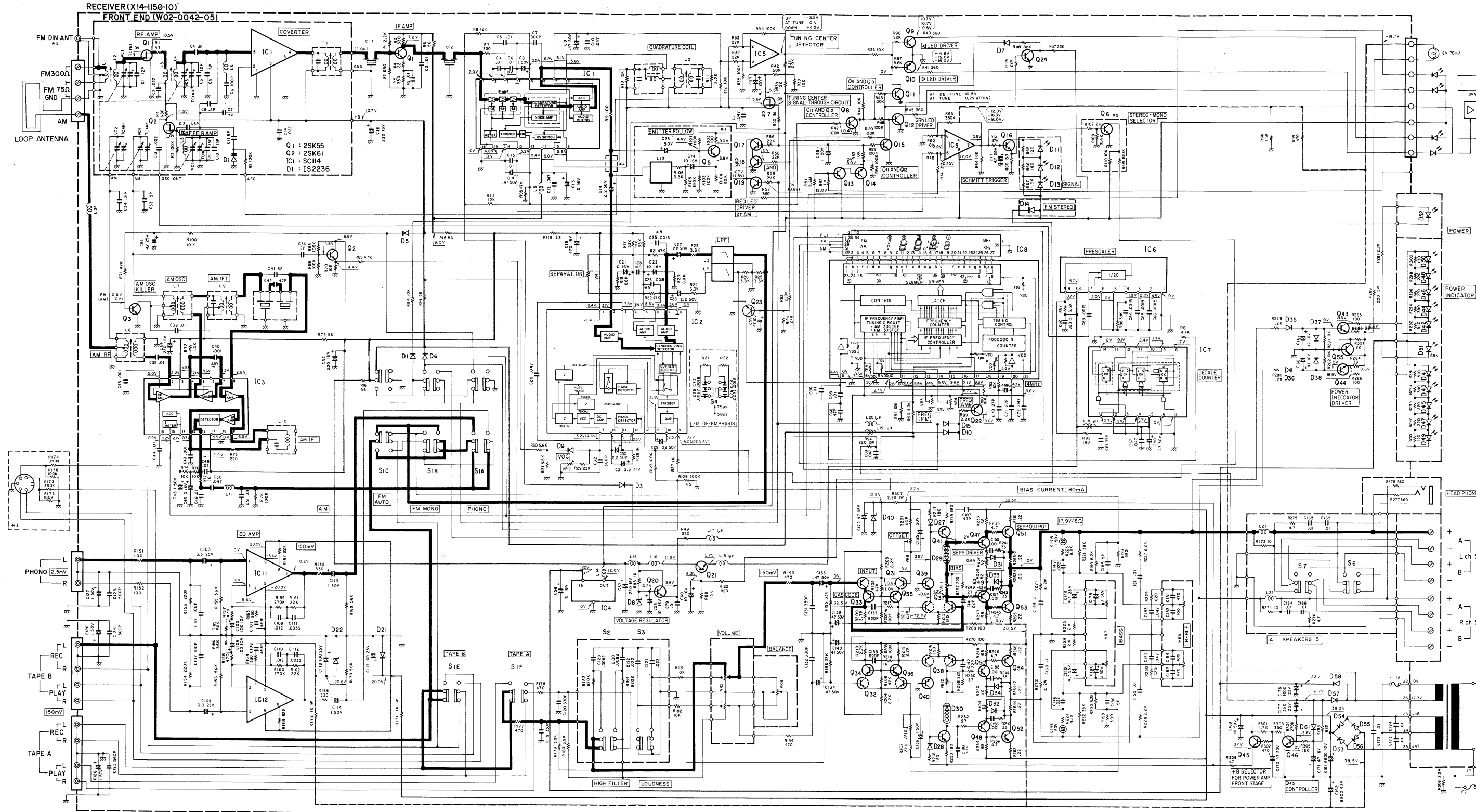

Q3 Q1 Q2 IC3 IC11,12 IC1 Q2 D22 Q1 Q1 D21 D1 D5 D6 IC1 D9 IC4 IC2 Q20 Q21,Q5 Q17~19, IC5, Q7, 23 Q13, 8, 14 Q31~36 Q9~12, 15 Q37~42 IC5 Q22 Q47~54 Q16 IC8 Q24 IC6 Q6 IC7 Q45 Q46 Q43, 44, 55 D27~30 D15, 10 D31~34 D7, 11~14 VR9~2 D41~52

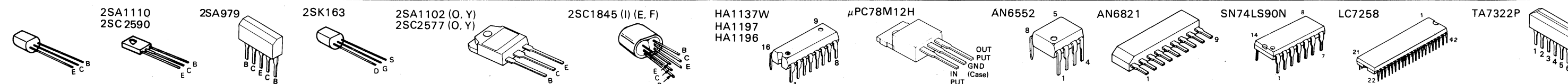



# HIGH SPEED DC/ZERO SWITCHING STEREO RECEIVER

# KR-720

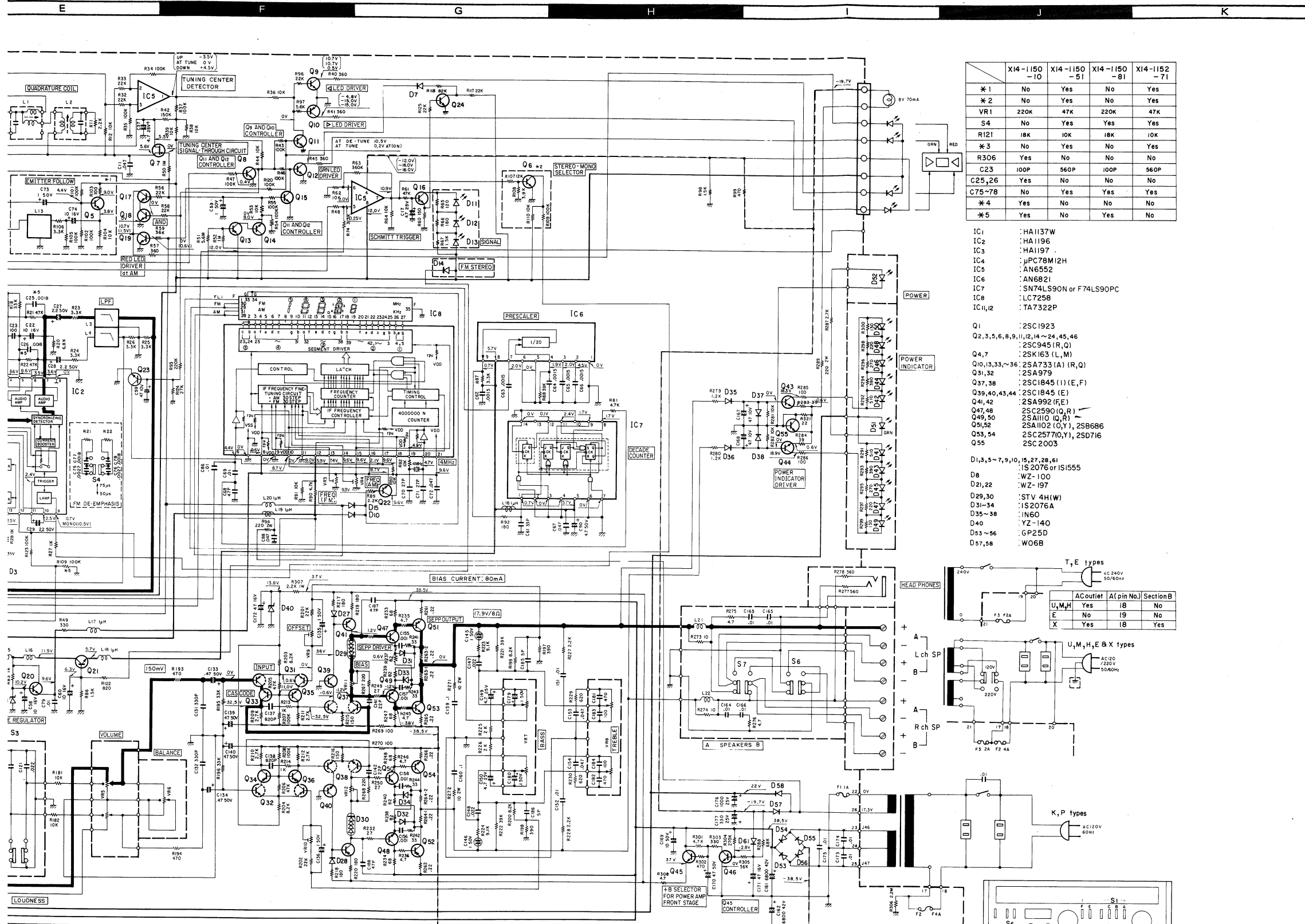

	X14-1150-10	X14-1150-51	X14-1150-81	X14-1152-71
*1	No	Yes	No	Yes
*2	No	Yes	No	Yes
VR1	220K	47K	220K	47K
S4	No	Yes	Yes	Yes
R121	18K	10K	18K	10K
*3	No	Yes	No	Yes
R306	Yes	No	No	No
C23	100P	560P	100P	560P
C25,26	Yes	No	No	No
C75-78	No	Yes	Yes	Yes
*4	Yes	No	No	No
*5	Yes	No	Yes	No

- IC1 : HA1137W
- IC2 : HA1196
- IC3 : HA1197
- IC4 :  $\mu$ PC78M12H
- IC5 : AN6552
- IC6 : AN6821
- IC7 : SN74LS90N or F74LS90PC
- IC8 : LC7258
- IC11,12 : TA7322P

- Q1 : 2SC1923
- Q2,3,5,6,8,9,11,12,14~24,45,46 : 2SC945(R,Q)
- Q4,7 : 2SK163(L,M)
- Q10,13,33~36 : 2SA733(A)(R,Q)
- Q31,32 : 2SA979
- Q37,38 : 2SC1845(I)(E,F)
- Q39,40,43,44 : 2SC1845(E)
- Q41,42 : 2SA992(FE)
- Q47,48 : 2SC2590(Q,R)
- Q49,50 : 2SA110(Q,R)
- Q51,52 : 2SA1102(Q,Y), 2SB686
- Q53,54 : 2SC2577(O,Y), 2SD716
- Q55 : 2SC2003

- D1,3,5~7,9,10,15,27,28,51 : 1S2076 or 1S1555
- D8 : WZ-100
- D21,22 : WZ-197
- D29,30 : STV 4H(W)
- D31~34 : 1S2076A
- D35~38 : 1N60
- D40 : YZ-140
- D53~56 : GP25D
- D57,58 : W06B

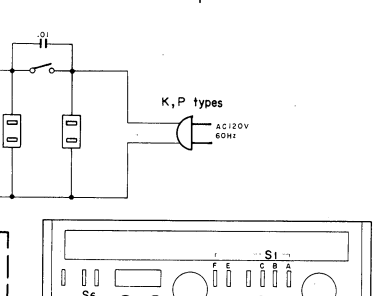

Q20 Q21,Q5 Q17~19,IC5,Q7,23 Q13,8,14 Q31~36 Q9~12,15 Q37~42 IC5 Q22 Q47~54 Q16 IC8,Q24 IC6 Q6 IC7 Q45 Q46 Q43,44,55 D77~30 D15,10 D31~34 D7,11~14 VR1,2 L1,2 VR5 VR6 VR9~g

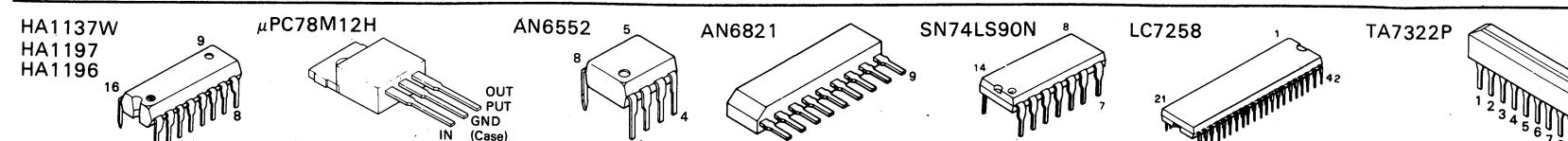

DC voltages are measured by a VOM of 20 k $\Omega$ /V input impedance.

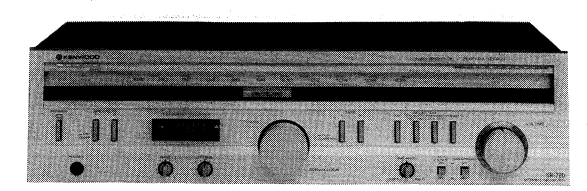

## SPECIFICATIONS

**AUDIO SECTION**  
**Power Output**  
 40 watts\* per channel, minimum RMS both channels driven, at 8 ohms from 20 Hz to 20,000 Hz with no more than 0.03% total harmonic distortion.

**Total Harmonic Distortion (20 Hz to 20 kHz from TAPE)**  
 rated power into 8 ohms ..... 0.03%  
 1 W power into 8 ohms ..... 0.01%  
**Intermodulation Distortion (60 Hz: 7 kHz = 4:1 SMPTE)**  
 rated power into 8 ohms ..... 0.025%  
 1 W power into 8 ohms ..... 0.01%

**Transient Response**  
 Rise Time ..... 1.5  $\mu$ s  
 Slew Rate .....  $\pm 50$  V/ $\mu$ s  
**Damping Factor** ..... 50 at 1 kHz, 8 ohms  
**Input Sensitivity/Impedance**  
 PHONO ..... 2.5 mV/50 kohms  
 TAPE ..... 150 mV/50 kohms

**Signal-to-Noise Ratio (A weighted)**  
 PHONO ..... 80 dB for 2.5 mV input  
 TAPE ..... 86 dB for 5.0 mV input  
 TAPE ..... 105 dB for 150 mV input

**Maximum Phono Input Level**  
 at 1,000 Hz ..... 200 mV (RMS), THD 0.03%

**Frequency Response**  
 PHONO RIAA Standard Curve ..... 30 Hz to 15 kHz  $\pm 0.4$  dB  
 TAPE ..... 5 Hz to 250 kHz  $-3$  dB

**Tone Control**  
 Bass .....  $\pm 8$  dB at 100 Hz  
 Treble .....  $\pm 8$  dB at 10 kHz  
**Loudness Control (VOL -30dB)** ..... +10 dB at 100 Hz  
**High Filter** ..... 5 kHz, 6 dB/oct

**Output Level/Impedance**  
 TAPE REC OUT (Pin) ..... 150 mV/300 ohms

**FM TUNER SECTION**  
**Usable Sensitivity** ..... 10.8 dBf (1.9  $\mu$ V)  
**50 dB Quieting Sensitivity**  
 Mono ..... 17.2 dBf (4.0  $\mu$ V)  
 Stereo ..... 37.2 dBf (40  $\mu$ V)

**Signal-to-Noise Ratio at 65 dBf**  
 Mono ..... 76 dB  
 Stereo ..... 71 dB

**Total Harmonic Distortion**  
 Mono ..... 0.1%  
 Stereo ..... 0.15%  
**Frequency Response** ..... 30 Hz to 15 kHz, +1 dB, -1.5 dB  
**Capture Ratio** ..... 1.0 dB  
**Image Rejection Ratio** ..... 48 dB  
**Spurious Response Ratio** ..... 70 dB  
**IF Response Ratio** ..... 90 dB  
**Alternate Channel Selectivity** ..... 52 dB at 400 kHz  
**AM Suppression Ratio** ..... 50 dB  
**Stereo Separation Ratio** ..... 45 dB at 1,000 Hz  
 35 dB at 50 Hz to 10 kHz  
**Antenna Impedance** ..... 300 ohms balanced & 75 ohms unbalanced  
**FM Frequency Range** ..... 88 MHz to 108 MHz

**AM TUNER SECTION**  
**Usable Sensitivity** ..... 15  $\mu$ V  
**Signal-to-Noise Ratio** ..... 50 dB  
**Image Rejection** ..... 40 dB  
**Selectivity** ..... 45 dB

**GENERAL**  
**Power Consumption** ..... 2.5 A (IUL and CSA)  
 190 W (8 ohms at rated power)  
 25 W (No Signal)  
 Switched 1, Unswitched 1

**AC Outlet** ..... Switched 1, Unswitched 1  
**Dimensions USA and Canada** ..... Other Countries  
 W: 458 mm (18-1/32") ..... 440 mm (17-5/16")  
 H: 123 mm (4-27/32") ..... 123 mm (4-27/32")  
 D: 298 mm (11-23/32") ..... 298 mm (11-23/32")  
**Weight**  
 (Net) 8 kg (17.1 lb) ..... 7.7 kg (16.9 lb)  
 (Gross) 9 kg (19.8 lb) ..... 8.7 kg (19.1 lb)

\*Measured pursuant to Federal Trade Commission's Trade Regulation rule on Power Output Claims for Amplifier in U.S.A.  
 Kenwood follows a policy of continuous advancements in development. For this reason specifications may be changed without notice.  
 Kenwood strebt ständige Verbesserungen in der Entwicklung an. Daher bleiben Änderungen der technischen Daten jederzeit vorbehalten.  
 Kenwood poursuit une politique de progrès constants en ce qui concerne le développement. Pour cette raison, les spécifications sont sujettes à modifications sans préavis.

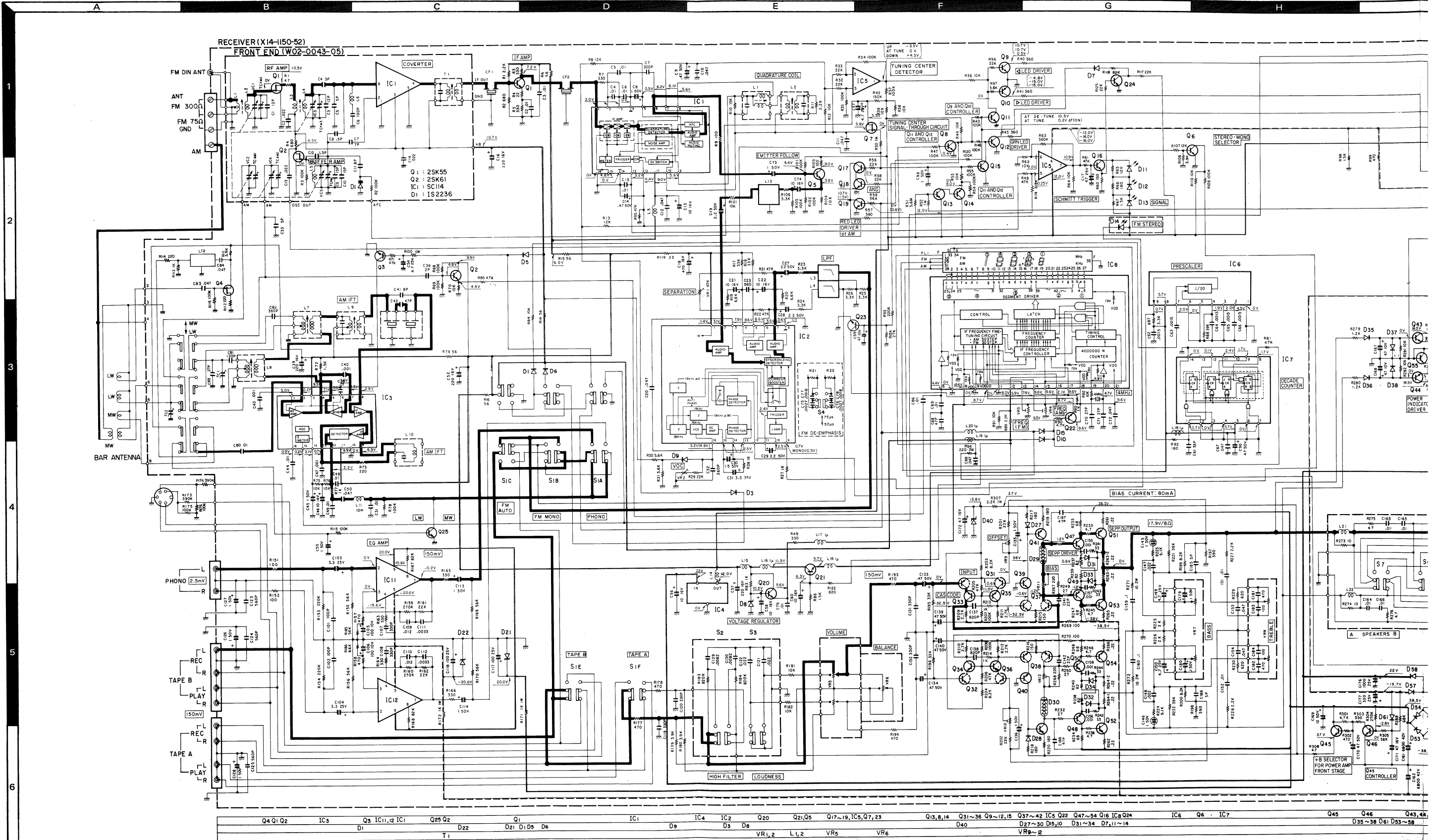

- |              |         |        |        |                |                    |         |           |        |        |           |        |
|--------------|---------|--------|--------|----------------|--------------------|---------|-----------|--------|--------|-----------|--------|
| 2SA733       | 2SA1110 | 2SA979 | 2SK163 | 2SA1102 (O. Y) | 2SC1845 (I) (E. F) | HA1137W | μPC78M12H | AN6552 | AN6821 | SN74LS90N | LC7258 |
| 2SA992 (F.E) | 2SC2590 |        |        | 2SC2577 (O. Y) |                    | HA1197  |           |        |        |           |        |
| 2SC945       |         |        |        |                |                    | HA1196  |           |        |        |           |        |
| 2SC1845 (F)  |         |        |        |                |                    |         |           |        |        |           |        |
| 2SC1923      |         |        |        |                |                    |         |           |        |        |           |        |

# HIGH SPEED DC/ZERO SWITCHING STEREO RECEIVER

# KR-720L

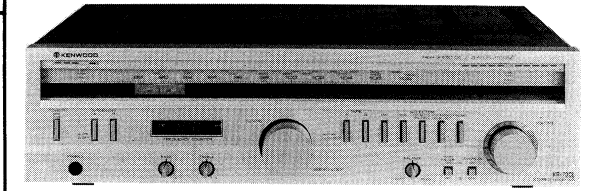

## SPECIFICATIONS

**AUDIO SECTION**  
 Rated Power Output  
 8 ohms at 20 Hz to 20 kHz  
 no more than 0.03% THD (FTC) ..... 40 W + 40 W  
 4 ohms at 63 Hz to 12.5 kHz  
 no more than 0.7% THD (IEC) ..... 45 W + 45 W  
 Total Harmonic Distortion  
 Rated Power Output into 8 ohms ..... 0.03%  
 Intermodulation Distortion ..... 0.025%  
 Frequency Response ..... 5 Hz - 250 kHz  
 +0 dB, -3 dB

**S/N Weighted: Rated Output Power (IEC-A)**  
 ( ) = Unweighted at 50 mW (DIN)  
 Phono MM ..... 80 dB (55 dB)  
 Tuner, Tape ..... 105 dB (55 dB)  
 Damping Factor at 8 ohms 1 kHz ..... 50  
 Transient Response  
 Rise Time ..... 1.5 μs  
 Slew Rate ..... ±50 V/μs  
 Input Sensitivity/Impedance  
 Phono ..... 2.5 mV/50 kohms  
 Tuner, Tape ..... 150 mV/50 kohms  
 Tone Control  
 Bass: 100 Hz ..... ±8 dB  
 Treble: 10 kHz ..... ±8 dB  
 Loudness Control (-30 dB) ..... 100 Hz, +10 dB  
 High Filter ..... 5 kHz, 6 dB/oct.

**FM TUNER SECTION**  
 Sensitivity at 75 ohms  
 Mono: S/N 26 dB, 40 kHz Dev. .... 1 μV  
 Stereo: S/N 46 dB, 46 kHz Dev. .... 30 μV  
 50 dB Quieting Sensitivity Mono (IHF) ..... 4 μV  
 Limiting Level  
 -3 dB Point, 40 kHz Dev. .... 0.8 μV  
 Frequency Response ..... 30 Hz - 15 kHz  
 +1 dB, -1.5 dB

**Total Harmonic Distortion**  
 Mono: 1 kHz, 40 kHz Dev. .... 0.12%  
 Stereo: 1 kHz, 46 kHz Dev. .... 0.2%  
**S/N Weighted (IEC-A)**  
 Mono: 40 kHz Dev., 1 mV Input ..... 72 dB  
 Stereo: 46 kHz Dev., 1 mV Input ..... 68 dB  
**S/N Ratio (IHF)**  
 Mono: 75 kHz Dev., 1 mV Input ..... 76 dB  
 Stereo: 75 kHz Dev., 1 mV Input ..... 71 dB  
**FM Stereo Separation: 1 mV Input (DIN)**

250 Hz ..... 34 dB  
 1 kHz ..... 36 dB  
 6.3 kHz ..... 26 dB  
 12.5 kHz ..... 22 dB  
**Image Rejection Ratio**  
 Selectivity  
 300 kHz, 20 dB Input ..... 60 dB  
**IF Rejection Ratio** ..... 90 dB  
**AM Suppression Ratio** ..... 50 dB  
**Spurious Response Ratio** ..... 70 dB  
**Capture Ratio** ..... 1.0 dB  
 Pilot Tone 19 kHz ..... 47 dB

**MW TUNER SECTION**  
 Sensitivity S/N 20 dB ..... 20 μV  
 S/N Ratio: 1 mV Input ..... 50 dB  
**Image Rejection Ratio** ..... 40 dB

**LW TUNER SECTION**  
 Sensitivity S/N 20 dB ..... 20 μV  
 S/N Ratio: 1 mV Input ..... 50 dB  
**Image Rejection Ratio** ..... 40 dB

**GENERAL**  
**Power Consumption**  
 Rated Power at 8 ohms ..... 190 W  
 No signal ..... 25 W  
**Dimensions**  
 W: 440 mm  
 H: 123 mm  
 D: 298 mm  
**Weight (Net)** ..... 7.7 kg

Kenwood follows a policy of continuous advancements in development. For this reason specifications may be changed without notice.

Kenwood strebt ständige Verbesserungen in der Entwicklung an. Daher bleiben Änderungen der technischen Daten jederzeit vorbehalten.

Kenwood poursuit une politique de progrès constants en ce qui concerne le développement. Pour cette raison, les spécifications sont sujettes à modifications sans préavis.

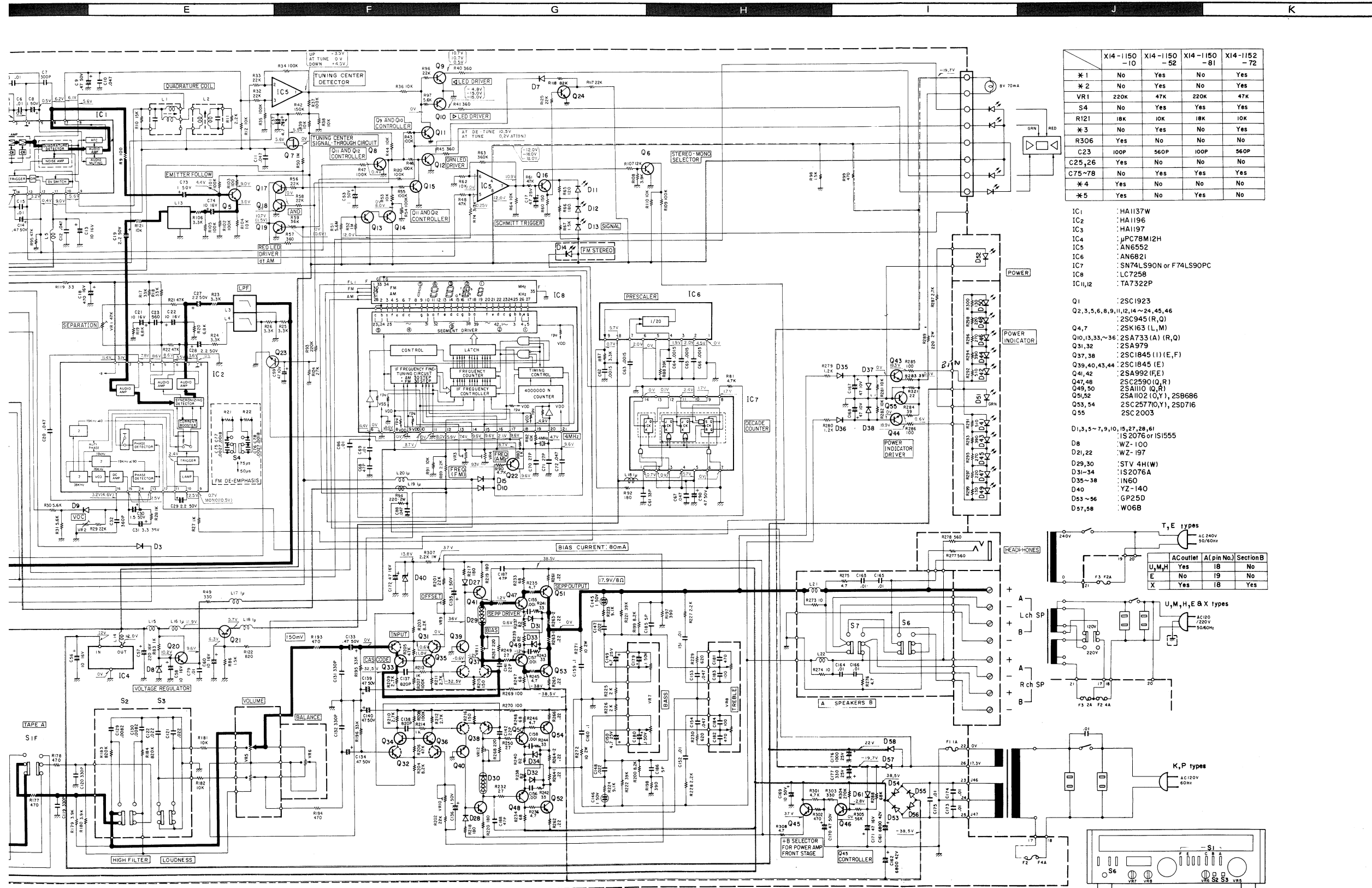

	X14-1150-10	X14-1150-52	X14-1150-81	X14-1152-72
*1	No	Yes	No	Yes
*2	No	Yes	No	Yes
VR1	220K	47K	220K	47K
S4	No	Yes	Yes	Yes
R121	18K	10K	18K	10K
*3	No	Yes	No	Yes
R306	Yes	No	No	No
C23	100P	560P	100P	560P
C25,26	Yes	No	No	No
C75-78	No	Yes	Yes	Yes
*4	Yes	No	No	No
*5	Yes	No	Yes	No

- IC1 : HA1137W
- IC2 : HA1196
- IC3 : HA1197
- IC4 : μPC78M12H
- IC5 : AN6552
- IC6 : AN6821
- IC7 : SN74LS90N or F74LS90PC
- IC8 : LC7258
- IC11,12 : TA7322P
- Q1 : 2SC1923
- Q2,3,5,6,8,9,11,12,14~24,45,46 : 2SC945 (R,Q)
- Q4,7 : 2SK163 (L,M)
- Q10,13,33~36 : 2SA733 (A) (R,Q)
- Q31,32 : 2SA979
- Q37,38 : 2SC1845 (I) (E,F)
- Q39,40,43,44 : 2SC1845 (E)
- Q41,42 : 2SA992 (F,E)
- Q47,48 : 2SC2590 (Q,R)
- Q49,50 : 2SA110 (Q,R)
- Q51,52 : 2SA1102 (O,Y), 2SB686
- Q53,54 : 2SC2577 (Y1), 2SD716
- Q55 : 2SC2003
- D1,3,5~7,9,10,15,27,28,61 : IS2076 or IS555
- D8 : WZ-100
- D21,22 : WZ-197
- D29,30 : STV 4H(W)
- D31~34 : IS2076A
- D35~38 : IN60
- D40 : YZ-140
- D53~56 : GP25D
- D57,58 : W06B

	T <sub>E</sub> types	AC outlet	A (pin No)	Section B
U <sub>M,H</sub>	Yes	IB	No	
E	No	IB	No	
X	Yes	IB	Yes	

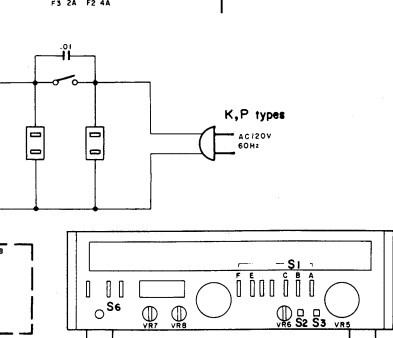
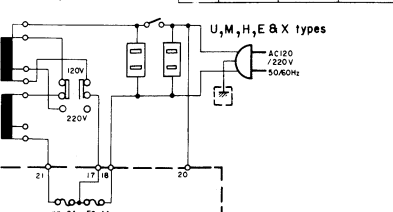

IC1	D9	IC4	IC2	Q20	Q21,Q5	Q17~19, IC5, Q7, 23	Q13, 8, 14	Q31~36	Q9~12, 15	Q37~42	IC8	Q22	Q47~54	Q16	IC9, Q24	IC6	Q6	IC7	Q45	Q46	Q43, 44, 55	D41~52
				VR1,2	L1,2	VR5	VR6	D40	VR9~2													

- 2SC1845 (I) (E, F)
- HA1137W
- HA1197
- HA1196
- μPC78M12H
- AN6552
- AN6821
- SN74LS90N
- LC7258
- TA7322P

DC voltages are measured by a VOM of 20 kΩ/V input impedance.



# PARTS LIST

## INSTRUCTION FOR PARTS LIST

Ref. No. 参照番号	Parts No. 部品番号	Description 部品名 / 規格	Re- marks 備考
② ① 18 1A	A01-0608-12	METALLIC CABINET	*K
19 2A	A20-1979-11	FRONT PANEL ASSY	PK
19 2A	A20-1979-11	FRONT PANEL ASSY	SU
19 2A	A20-1979-11	FRONT PANEL ASSY	XW
⑤ R221	R43-1333-15	FL-PROOF RD330 J 2H	*
R222	R43-1368-15	FL-PROOF RD680 J 2H	*
VR1 ,2	R12-3301-05	TRIMMING POT, 20K(B)	*
VR3 ,4	R19-4305-05	POTENTIOMETER (OUTPUT)	*
VR5 ,6	R12-2302-05	TRIMMING POT, 5K(B)	*

- ① Exploded view drawing No.
- ② Position in exploded view.
- ③ Symbol of new parts.
- ④ Area to which parts are shipped. Example: A20-1390-13 is the part No. of FRONT PANEL ASSY for the "K" type products (for U.S.A.). When this column is blank, it means that the same type of parts (same parts No.) are used for the products shipped to all areas.

- ⑤ Reference No. in schematic diagram.
- ⑥ Abbreviation of "ceramic capacitor".  
All capacitors and resistors are listed using abbreviations.

\* Abbreviations of capacitors (Parts No. with initial letter "C").

ELECTRO	Electrolytic capacitor
LL-ELEC	Low leak electrolytic capacitor
NP-ELEC	Non-pole electrolytic capacitor
MICA	Mica capacitor
POLYSTY	Polystyrene capacitor
MYLAR	Mylar capacitor
CERAMIC	Ceramic capacitor
TANTAL	Tantalum capacitor
MF	Metallized film capacitor
MP	Metallized paper capacitor
OIL	Oil capacitor

The unit "UF" is used in lieu of "μF".

\* Abbreviations of resistors (Parts No. with initial letters "R").

RC	Carbon composition resistor
RD	Carbon film resistor
FL-PROOF RD	Flame-proof carbon film resistor
RW	Wire wound power resistor
FL-PROOF RS	Flame-proof metal oxide film resistor
RN	Metal film resistor
FUSE-RESIST	Resistor with fuse function
2B	Rated wattage 1/8W
2E	Rated wattage 1/4W
2H	Rated wattage 1/2W
3A	Rated wattage 1W
3D	Rated wattage 2W
3F	Rated wattage 3W
3G	Rated wattage 4W
3H	Rated wattage 5W

All resistor values are indicated with the unit (Ω) omitted.

\* Abbreviations common to capacitors and resistors.

C	±0.25pF (Used for capacitors only)
D	±0.5pF (Used for capacitors only)
F	±1%
G	±2%
J	±5%
K	±10%
M	±20%
Z	+80%, -20%(Used for capacitors only)
P	+100%, -0%(Used for capacitors only)

Resistors RD (carbon composition resistors) are not listed in the parts list. For values, refer to the schematic diagram.

\* CODEs in X14-115

K	X14-1150-10	E	X14-1152-71
U	X14-1150-81	T	X14-1150-52
T	X14-1150-51	E	X14-1152-72

Ref. No. 参照番号	Parts No. 部品番号	Description 部品名 / 規格	Re- marks 備考
<b>KR-720 (L) UNIT</b>			
1	1B	-	REAR PANEL
2	3B	-	BOTTOM PLATE
3	3A	-	DRESSING PLATE
4	3A	-	DRESSING PLATE
-	351-0009-04	FIBER STICK AND STRING	
11	1A	A01-0373-03	METALLIC CABINET *K
11	1A	A01-0373-03	METALLIC CABINET P
11	1A	A01-0374-03	METALLIC CABINET *U
11	1A	A01-0374-03	METALLIC CABINET MH
11	1A	A01-0374-03	METALLIC CABINET XT
11	1A	A01-0374-03	METALLIC CABINET [E]
11	1A	A01-0374-03	METALLIC CABINET [TK]
11	1A	A01-0374-03	METALLIC CABINET [UE]
12	3A	A20-1605-03	FRONT PANEL ASSY *K
12	3A	A20-1605-03	FRONT PANEL ASSY PU
12	3A	A20-1605-03	FRONT PANEL ASSY MH
12	3A	A20-1605-03	FRONT PANEL ASSY XE
12	3A	A20-1605-03	FRONT PANEL ASSY [UE]
12	3A	A20-1606-03	FRONT PANEL ASSY *T
12	3A	A20-1647-03	FRONT PANEL ASSY *E
12	3A	A20-1648-03	FRONT PANEL ASSY *T
12	3A	A20-1703-03	FRONT PANEL ASSY *K
13	2A	A22-0271-03	SUB PANEL *
14	1A	A50-0078-03	SIDE PLATE (L) *K
14	1A	A50-0078-03	SIDE PLATE (L) PK
15	1B	A50-0079-03	SIDE PLATE (R) *K
15	1B	A50-0079-03	SIDE PLATE (R) PK
-	B46-0055-20	WARRANTY CARD	P
-	B46-0060-00	WARRANTY CARD	[T]
-	B46-0061-20	WARRANTY CARD	[K]
-	B46-0062-20	WARRANTY CARD	UH
-	B46-0062-20	WARRANTY CARD	[UE]
-	B46-0063-13	WARRANTY CARD	UH
-	B46-0063-13	WARRANTY CARD	[UE]
-	B46-0064-10	WARRANTY CARD	X
-	B50-3117-00	INSTRUCTION MANUAL	*K
-	B50-3117-00	INSTRUCTION MANUAL	PU
-	B50-3117-00	INSTRUCTION MANUAL	MH
-	B50-3117-00	INSTRUCTION MANUAL	X
-	B50-3117-00	INSTRUCTION MANUAL	[UE]
-	B50-3118-00	INSTRUCTION MANUAL	*P
-	B50-3118-00	INSTRUCTION MANUAL	MX
-	B50-3119-00	INSTRUCTION MANUAL	*T
-	B50-3147-00	INSTRUCTION MANUAL	*E
-	B50-3148-00	INSTRUCTION MANUAL	[E]
-	B50-3149-00	INSTRUCTION MANUAL	[T]
-	B50-3189-00	INSTRUCTION MANUAL	[E]
-	B50-3213-00	INSTRUCTION MANUAL	*K
-	B59-0018-00	INSTRUCTION PRINT	UH
-	B59-0018-00	INSTRUCTION PRINT	[UE]
16	3A	B10-0264-04	FRONT GLASS
17	3A	B10-0267-04	FRONT GLASS
18	3A	B20-0463-04	DIAL CALIBRATIONS *K
18	3A	B20-0463-04	DIAL CALIBRATIONS PU
18	3A	B20-0463-04	DIAL CALIBRATIONS MH
18	3A	B20-0463-04	DIAL CALIBRATIONS XT
18	3A	B20-0463-04	DIAL CALIBRATIONS E
18	3A	B20-0463-04	DIAL CALIBRATIONS [UE]
18	3A	B20-0473-04	DIAL CALIBRATIONS *E

## PARTS LIST

Ref. No. 参照番号	Parts No. 部品番号	Description 部品名/規格	Re- marks 備考
18 3A	B20-0473-04	DIAL CALIBRATIONS	TT
18 3A	B20-0478-04	DIAL CALIBRATIONS	K
19 3A	B21-0041-05	DIAL POINTER	*
-	C91-0023-05	CERAMIC 0.01UF P	UM
-	C91-0023-05	CERAMIC 0.01UF P	HX
-	C91-0023-05	CERAMIC 0.01UF P	UE
-	C91-0079-05	CERAMIC 0.01UF Z	KP
-	C91-0079-05	CERAMIC 0.01UF Z	TE
-	C91-0079-05	CERAMIC 0.01UF Z	ET
-	C91-0079-05	CERAMIC 0.01UF Z	K
20 2A	D15-0164-04	PULLEY	
21 2B,3B	D15-0172-04	PULLEY X4	
22 2A	D15-0175-05	PULLEY	
23 2B	D20-0154-03	DIAL SHAFT	*
-	E23-0015-04	TERMINAL	
25 1B	E03-0017-05	AC OUTLET X2	K
25 1B	E03-0017-05	AC OUTLET X2	KP
25 1B	E03-0031-05	AC OUTLET X2	UM
25 1B	E03-0031-05	AC OUTLET X2	HX
25 1B	E03-0031-05	AC OUTLET X2	UE
26 1B	E04-0004-05	RECEPTACLE	TE
26 1B	E04-0004-05	RECEPTACLE	ET
27 1B	E30-0181-05	POWER CORD	KP
27 1B	E30-0181-05	POWER CORD	K
27 1B	E30-0459-05	POWER CORD	EE
27 1B	E30-0545-05	POWER CORD	UM
27 1B	E30-0545-05	POWER CORD	H
27 1B	E30-0545-05	POWER CORD	UE
27 1B	E30-0587-05	POWER CORD	TT
27 1B	E30-0649-05	POWER CORD	X
28 2A	G01-0045-24	COIL SPRING	
-	H01-3159-04	CARTON BOX	*K
-	H01-3159-04	CARTON BOX	P
-	H01-3161-04	CARTON BOX	*U
-	H01-3161-04	CARTON BOX	MH
-	H01-3161-04	CARTON BOX	X
-	H01-3161-04	CARTON BOX	UE
-	H01-3162-04	CARTON BOX	*T
-	H01-3163-04	CARTON BOX	*E
-	H01-3164-04	CARTON BOX	*E
-	H01-3165-04	CARTON BOX	*T
-	H01-3195-04	CARTON BOX	*K
-	H10-1551-02	POLYSTYRENE FIXTURE	*
-	H10-1552-02	POLYSTYRENE FIXTURE	*
-	H20-0417-04	COVER	M
-	H20-0452-04	COVER	KP
-	H20-0452-04	COVER	UH
-	H20-0452-04	COVER	XT
-	H20-0452-04	COVER	EE
-	H20-0452-04	COVER	TK
-	H20-0452-04	COVER	UE
-	H25-0078-04	BAG	
-	J61-0045-05	WIRE BAND	
29 3A,3B	J02-0088-05	FOOT X4	KK
29 3A,3B	J02-0089-05	FOOT X4	PU
29 3A,3B	J02-0089-05	FOOT X4	MH
29 3A,3B	J02-0089-05	FOOT X4	XT
29 3A,3B	J02-0089-05	FOOT X4	EE
29 3A,3B	J02-0089-05	FOOT X4	T

Ref. No. 参照番号	Parts No. 部品番号	Description 部品名/規格	Re- marks 備考
29 3A,3B	J02-0089-05	FOOT X4	UE
30 1B	J19-0507-05	HOLDER	ET
31 1B	J19-0564-05	HOLDER	K
31 1B	J19-0564-05	HOLDER	KP
31 1B	J19-0564-05	HOLDER	UM
31 1B	J19-0564-05	HOLDER	HX
31 1B	J19-0564-05	HOLDER	TE
31 1B	J19-0564-05	HOLDER	UE
31 1B	J19-0564-05	HOLDER	K
31 1B	J19-0564-05	HOLDER	KP
31 1B	J19-0564-05	HOLDER	K
32 1B	J41-0034-05	BUSHING	UM
32 1B	J41-0034-05	BUSHING	HT
32 1B	J42-0084-05	BUSHING	EE
32 1B	J42-0084-05	BUSHING	TT
32 1B	J42-0084-05	BUSHING	UE
32 1B	J42-0085-05	BUSHING	X
33 3A	K23-0339-04	KNOB	*
34 2A,2B	K27-0132-04	KNOB X8	*K
34 2A,2B	K27-0132-04	KNOB X8	PU
34 2A,2B	K27-0132-04	KNOB X8	MH
34 2A,2B	K27-0132-04	KNOB X8	XT
34 2A,2B	K27-0132-04	KNOB X8	UE
34 2A,2B	K27-0132-04	KNOB X8	K
34 2A,2B	K27-0132-04	KNOB X8	ET
34 2A,2B	K27-0132-04	KNOB X8	ET
35 2B	K27-0133-04	KNOB X2	*
36 2A	K27-0136-04	KNOB	*
37 3A	K29-0347-04	KNOB	*
38 2A,3A	K29-0348-04	KNOB X3	*
39 2A	L01-2021-05	POWER TRANSFORMER	*K
39 2A	L01-2021-05	POWER TRANSFORMER	K
39 2A	L01-2022-05	POWER TRANSFORMER	*T
39 2A	L01-2022-05	POWER TRANSFORMER	T
39 2A	L01-2026-05	POWER TRANSFORMER	*E
39 2A	L01-2026-05	POWER TRANSFORMER	E
39 2A	L01-2027-05	POWER TRANSFORMER	*P
39 2A	L01-2028-05	POWER TRANSFORMER	*U
39 2A	L01-2028-05	POWER TRANSFORMER	MH
39 2A	L01-2028-05	POWER TRANSFORMER	X
39 2A	L01-2028-05	POWER TRANSFORMER	UE
40 1B	N08-0125-05	M4X8(BI-TAP)	UM
40 1B	N08-0125-05	M4X8(BI-TAP)	HX
40 1B	N08-0125-05	M4X8(BI-TAP)	TE
40 1B	N08-0125-05	M4X8(BI-TAP)	ET
40 1B	N08-0125-05	M4X8(BI-TAP)	UE
40 1B	N08-0125-05	M4X8(BI-TAP)	K
41 1A,1B	N09-0308-05	M4X16(BI-TAP)	KP
41 1A,1B	N09-0308-05	M4X16(BI-TAP)	K
42 2B	N08-0128-05	GND SCREW	
43 2B,3B	N09-0293-05	M2.6X14	
44 2B	N09-0303-05	M3X6	TE
44 2B	N09-0303-05	M3X6	ET
45 2A	N29-0033-05	PUSH RIVET	
46 2B	S31-2050-05	SLIDE SWITCH	UM
46 2B	S31-2050-05	SLIDE SWITCH	HX
46 2B	S31-2050-05	SLIDE SWITCH	EE
46 2B	S31-2050-05	SLIDE SWITCH	UE
47 2B	S40-1010-05	PUSH SWITCH	UM
47 2B	S40-1010-05	PUSH SWITCH	HX
47 2B	S40-1010-05	PUSH SWITCH	UE
47 2B	S40-1011-05	PUSH SWITCH	KP

PARTS LIST

Ref. No. 参照番号	Parts No. 部品番号	Description 部品名 / 規格	Re- marks 備考
47 2B	S40-1011-05	PUSH SWITCH	[K]
47 2B	S40-2099-05	PUSH SWITCH	TE
47 2B	S40-2099-05	PUSH SWITCH	[E]
	T90-0202-05	ANTENNA FM	
48 1B	T90-0087-05	ANTENNA AM BAR	ET
49 1B	T90-0104-05	ANTENNA AM LOOP	KP
49 1B	T90-0104-05	ANTENNA AM LOOP	UM
49 1B	T90-0104-05	ANTENNA AM LOOP	HX
49 1B	T90-0104-05	ANTENNA AM LOOP	TE
49 1B	T90-0104-05	ANTENNA AM LOOP	[E]
49 1B	T90-0104-05	ANTENNA AM LOOP	[K]
50 2A	X14-1150-10	RECEIVER PCB ASSY	*K
50 2A	X14-1150-10	RECEIVER PCB ASSY	P[K]
50 2A	X14-1150-51	RECEIVER PCB ASSY	*T
50 2A	X14-1150-52	RECEIVER PCB ASSY	*T
50 2A	X14-1150-81	RECEIVER PCB ASSY	*U
50 2A	X14-1150-81	RECEIVER PCB ASSY	MH
50 2A	X14-1150-81	RECEIVER PCB ASSY	X
50 2A	X14-1150-81	RECEIVER PCB ASSY	[E]
50 2A	X14-1152-71	RECEIVER PCB ASSY	*E
50 2A	X14-1152-72	RECEIVER PCB ASSY	*E
<b>RECEIVER (X14-115)</b>			
D11 -13	B30-0231-05	LED	
D14	B30-0230-05	LED	
D41 -50	B30-0230-05	LED	
D51	B30-0231-05	LED	
D52	B30-0230-05	LED	
C2 -6	C55-1710-38	CERAMIC 0.01UF Z	
C7	C71-1722-15	CERAMIC 220PF J	
C8	C24-1701-01	ELECTRO 1UF 50WV	
C9	C24-1747-41	ELECTRO 0.47UF 50WV	
C10 -12	C55-1747-38	CERAMIC 0.047UF Z	
C13	C24-1210-61	ELECTRO 10UF 16WV	
C14	C24-1747-48	ELECTRO 0.47UF 50WV	
C15	C55-1710-38	CERAMIC 0.01UF Z	
C16	C24-1222-71	ELECTRO 220UF 16WV	
C17	C24-1447-51	ELECTRO 4.7UF 25WV	
C18	C24-1247-71	ELECTRO 470UF 16WV	
C19	C24-1722-51	ELECTRO 2.2UF 50WV	
C20	C46-1747-35	MYLAR 0.047UF J	
C21 ,22	C24-1210-61	ELECTRO 10UF 16WV	
C23	C71-1710-16	CERAMIC 100PF J	KU
C23	C71-1756-16	CERAMIC 560PF J	TE
C23	C71-1756-16	CERAMIC 560PF J	[E]
C25 ,26	C46-1718-25	MYLAR 0.0018UF J	K
C27 -30	C24-1722-51	ELECTRO 2.2UF 50WV	
C31	C24-1733-51	ELECTRO 3.3UF 50WV	
C32	C48-1736-15	POLYSTY 360PF J	
C33	C70-1705-02	CERAMIC 5PF C	
C34	C70-1712-05	CERAMIC 12PF J	
C35	C55-1710-38	CERAMIC 0.01UF Z	KT
C35	C55-1710-38	CERAMIC 0.01UF Z	UE
C36	C71-1702-01	CERAMIC 2PF C	
C37	C24-1447-51	ELECTRO 4.7UF 25WV	
C38	C55-1710-38	CERAMIC 0.01UF Z	
C39	C24-1222-71	ELECTRO 220UF 16WV	KU
C40	C52-1710-26	CERAMIC 0.001UF K	
C41	C71-1708-02	CERAMIC 8PF D	KT
C41	C71-1708-02	CERAMIC 8PF D	[E]
C42	C71-1747-05	CERAMIC 47PF J	
C43	C52-1710-26	CERAMIC 0.001UF K	
C44	C55-1710-38	CERAMIC 0.01UF Z	

Ref. No. 参照番号	Parts No. 部品番号	Description 部品名 / 規格	Re- marks 備考
C45	C24-1710-51	ELECTRO 1UF 50WV	
C46	C24-1210-61	ELECTRO 10UF 16WV	
C47	C52-1710-26	CERAMIC 0.001UF K	
C48 ,49	C55-1710-38	CERAMIC 0.01UF Z	
C50	C46-1747-35	MYLAR 0.047UF J	
C51	C55-1710-38	CERAMIC 0.01UF Z	
C52	C24-1222-71	ELECTRO 220UF 16WV	
C53	C24-1710-51	ELECTRO 1UF 50WV	
C54	C24-1447-51	ELECTRO 4.7UF 25WV	TE
C55	C24-1710-51	ELECTRO 1UF 50WV	[E]
C55	C24-1710-51	ELECTRO 1UF 50WV	TE
C56	C24-1410-61	ELECTRO 10UF 25WV	
C57	C24-1222-71	ELECTRO 220UF 16WV	
C58	C24-1210-61	ELECTRO 10UF 16WV	
C59	C24-1047-61	ELECTRO 47UF 10WV	
C60	C24-1210-61	ELECTRO 10UF 16WV	
C61	C71-1733-06	CERAMIC 33PF 50WV	
C62 -66	C52-1715-26	CERAMIC 0.0015UF K	
C67	C55-1747-38	CERAMIC 0.047UF Z	
C68	C71-1747-05	CERAMIC 47PF J	
C69	C55-1710-38	CERAMIC 0.01UF Z	
C70 ,71	C63-1727-05	CERAMIC 27PF J	
C72	C55-1747-38	CERAMIC 0.047UF Z	
C73	C24-1710-51	ELECTRO 1UF 50WV	TE
C73	C24-1710-51	ELECTRO 1UF 50WV	[E]
C74	C24-1210-61	ELECTRO 10UF 16WV	TE
C74	C24-1210-61	ELECTRO 10UF 16WV	[E]
C75,76	C46-1727-25	MYLAR 0.0027UF J	TE
C75,76	C46-1727-25	MYLAR 0.0027UF J	[E]
C77 ,78	C46-1718-25	MYLAR 0.0018UF J	TU
C77 ,78	C46-1718-25	MYLAR 0.0018UF J	[E]
C80	C55-1710-38	CERAMIC 0.01UF Z	e
C81	C47-1712-15	POLYSTY 120PF J	[E]
C82	C48-1736-15	POLYSTY 360PF J	[E]
C83 ,84	C46-1747-35	MYLAR 0.047UF J	[E]
C85	C71-1727-06	CERAMIC 27PF J	[E]
C86	C55-1710-36	CERAMIC 0.01UF Z	[E]
C86	C55-1747-38	CERAMIC 0.047UF Z	[E]
C90	C24-1747-41	ELECTRO 0.47UF 50WV	[E]
C101,102	C71-1710-15	CERAMIC 100PF J	
C103,104	C25-1433-57	LL-ELEC 3.3UF 25WV	
C105,106	C24-1010-71	ELECTRO 100UF 10WV	
C107,108	C52-1733-16	CERAMIC 330PF K	
C109,110	C46-1712-35	MYLAR 0.012UF J	
C111,112	C46-1733-25	MYLAR 0.0033UF J	
C113,114	C24-1710-51	ELECTRO 1UF 50WV	
C117,118	C24-1410-71	ELECTRO 100UF 25WV	
C119,120	C52-1733-16	CERAMIC 330PF K	
C121,122	C46-1722-35	MYLAR 0.022UF K	
C123-125	C52-1756-16	CERAMIC 560PF K	
C126-128	C24-1710-51	ELECTRO 1UF 50WV	
C129,130	C46-1782-25	MYLAR 0.0082UF K	
C131,132	C52-1733-16	CERAMIC 330PF K	
C133,134	C25-1747-47	LL-ELEC 0.47UF 50WV	
C135,136	C25-1710-57	LL-ELEC 1UF 50WV	
C137,138	C52-1782-16	CERAMIC 820PF K	
C139,140	C24-1747-61	ELECTRO 47UF 50WV	
C141,142	C71-1722-06	CERAMIC 22PF J	
C145,146	C26-1710-57	NP-ELEC 1UF 50WV	
C147,148	C46-1722-35	MYLAR 0.022UF K	
C149,150	C24-1447-51	ELECTRO 4.7UF 25WV	

# PARTS LIST

Ref. No. 参照番号	Parts No. 部品番号	Description 部品名 / 規格	Re- marks 備考
C151,152	C46-1710-35	MYLAR 0.01UF K	
C153,154	C46-1747-35	MYLAR 0.047UF K	
C155-158	C46-1710-26	MYLAR 0.001UF K	
C159,160	C46-1710-45	MYLAR 0.1UF M	
C161,162	C90-0468-05	ELECTRO 6800UF 42WF	
C163-166	C46-1710-35	MYLAR 0.01UF K	
C167,168	C24-1047-61	ELECTRO 47UF 10WV	
C169	C24-1710-61	ELECTRO 10UF 50WV	
C170	C24-1747-61	ELECTRO 47UF 50WV	
C171,172	C24-1247-61	ELECTRO 47UF 16WV	
C173,174	C54-2710-39	CERAMIC 0.01UF P	
C175	C54-2710-39	CERAMIC 0.01UF P	TE
C176	C24-1410-81	ELECTRO 1000UF 25WV	
C177	C24-1433-71	ELECTRO 330UF 25WV	
C179,180	C25-1710-47	LL-ELEC 0.1UF 50WV	
C181,182	C52-1747-16	CERAMIC 470PF K	
C183,184	C71-1710-15	CERAMIC 100PF J	
C185,186	C71-1705-01	CERAMIC 5PF C	
TC1,2	C05-0303-05	TRIMMER CAPACITOR	TE
-	E06-0513-05	R/P JACK	TE
-	E06-0513-05	R/P JACK	TE
-	E11-0074-05	PHONE JACK 3P	
-	E13-0423-05	PHONO JACK 4P	
-	E13-0612-05	PHONO JACK 6P	
-	E20-0439-05	TERMINAL BOARD 4P AMT	
24 2B	E20-0813-05	TERMINAL BOARD 8P SP	
-	E23-0047-04	TERMINAL	
-	E23-0104-05	TERMINAL	
-	E40-0873-05	PIN CONNECTOR 8P	
F1	F05-2021-05	FUSE 250V 2A	K
F1	F05-2023-05	FUSE 250V 2A	U
F1	F05-2029-05	FUSE 250V F2A	TE
F1	F05-2029-05	FUSE 250V F2A	TE
F2	F05-4021-05	FUSE 250V 4A	K
F2	F05-4022-05	FUSE 250V 4A	U
F2	F05-4024-05	FUSE 250V F4A	EE
F3	F05-2023-05	FUSE 250V 2A	U
F3	F05-2029-05	FUSE 250V F2A	TE
F3	F05-2029-05	FUSE 250V F2A	TE
-	J13-0055-05	FUSE HOLDER X4	KU
-	J13-0055-05	FUSE HOLDER X4	T
-	J13-0055-05	FUSE HOLDER X6	EE
-	J13-0055-05	FUSE HOLDER X6	U
-	J19-0569-04	HOLDER	*
-	J19-0570-03	HOLDER	*
-	J19-0571-04	HOLDER	*
CF1,2	L72-0052-15	CERAMIC FILTER	KU
CF1,2	L79-0123-05	FILTER	TE
CF1,2	L79-0123-05	FILTER	TE
CF3	L72-0078-05	CERAMIC FILTER	TE
L1	L30-0316-05	IFT FM	
L2	L30-0317-05	IFT FM	
L3	L79-0127-05	FILTER L.P.F	
L5	L40-2292-44	INDUCTOR 2.2UH,M	
L6	L31-0458-05	RF COIL MW	KT
L6	L31-0458-05	RF COIL MW	UE
L7	L32-0244-05	OSCILLATING COIL MW	*K
L7	L32-0244-05	OSCILLATING COIL MW	TU
L7	L32-0244-05	OSCILLATING COIL MW	E
L7	L32-0246-05	OSCILLATING COIL MW	*T
L7	L32-0246-05	OSCILLATING COIL MW	E

Ref. No. 参照番号	Parts No. 部品番号	Description 部品名 / 規格	Re- marks 備考
L8	L32-0242-05	OSCILLATING COIL Lw	TE
L9	L30-0329-05	IFT AM	
L10	L30-0284-05	IFT AM	
L11	L40-1021-11	INDUCTOR 1.0MH,K	KT
L11	L40-1021-11	INDUCTOR 1.0MH,K	UE
L11	L40-1035-05	INDUCTOR 1.0MH,J	TE
L12	L79-0119-05	FILTER L.P.F	TE
L13	L79-0109-05	FILTER L.P.F	TE
L13	L79-0109-05	FILTER L.P.F	TE
L14	L40-1092-11	INDUCTOR 1.0UH,M	
L15	L40-1021-11	INDUCTOR 1.0MH,M	
L16	L40-1092-12	INDUCTOR 1.0UH,M	
L17,18	L40-1092-11	INDUCTOR 1.0UH,M	
L19,20	L40-1092-12	INDUCTOR 1.0UH,M	
L21,22	L39-0085-05	COIL	
L23	L40-1092-12	INDUCTOR 1.0UH,M	
L24	L40-1092-11	INDUCTOR 1.0UH,M	
X1	L77-0574-05	CRYSTAL RESONATOR	
-	N09-0321-05	SCREW	
-	N29-0033-05	PUSH RIVET	
R51	R40-8356-58	RC 5.6M M 2H	
R94	R47-1522-15	RS 220 J 3D	
R171,172	R47-1410-25	RS 1K J 3A	
R261,262	R92-0166-05	METAL 0.22 J 3A	
R263,264	R90-0138-05	RESISTOR 0.22 K 3F	*
R265,266	R92-0166-05	METAL 0.22 J 3A	
R271,272	R47-1510-05	RS 10 J 3D	
R273,274	R40-8310-06	RC 10 K 2H	
R275,276	R47-1447-95	RS 4.7 J 3A	
R277,278	R47-1456-15	RS 560 J 2H	TE
R285,286	R47-1410-15	RS 100 K 2H	
R287	R47-1427-25	RS 2.7K K 2H	
R289	R47-1522-15	RS 220 J 3D	
R306	R92-0173-05	RC 2.2M M 2H	K
R307	R47-1422-25	RS 2.2K J 3A	
VR1	R12-3046-05	TRIMMING POT.47K	TE
VR1	R12-3046-05	TRIMMING POT.47K	TE
VR1	R12-5031-05	TRIMMING POT.220K	KU
VR2 -4	R12-3045-05	TRIMMING POT.10K	
VR5	R06-5055-05	POTENTIOMETER	*
VR6	R05-5004-05	POTENTIOMETER	*
VR7,8	R10-4005-05	POTENTIOMETER	*
VR9,10	R12-3051-05	TRIMMING POT.22K	
VR11,12	R12-0078-05	TRIMMING POT.500	
-	S90-0037-05	REMOTE WIRE	*T
-	S90-0037-05	REMOTE WIRE	E
S1	S42-6008-05	PUSH SWITCH 6 KEY	*K
S1	S42-6008-05	PUSH SWITCH 6 KEY	TU
S1	S42-6008-05	PUSH SWITCH 6 KEY	E
S1	S42-7003-05	PUSH SWITCH 7 KEY	*T
S1	S42-7003-05	PUSH SWITCH 7 KEY	E
S1	S90-0035-05	SLIDE SWITCH	TE
S2,3	S40-2110-05	PUSH SWITCH	*
S4	S31-2047-05	SLIDE SWITCH	TU
S4	S31-2047-05	SLIDE SWITCH	E
S4	S31-2047-05	SLIDE SWITCH	TE
S6	S42-2035-05	PUSH SWITCH 2 KEY	*
-	V40-4400-20	FIP788S FLUORESCENT	
D1,3	V11-0271-05	1S2076,1S1555	
D5 -7	V11-0271-05	1S2076,1S1555	
D8	V11-0247-05	W2-100	
D9,10	V11-0271-05	1S2076,1S1555	

PARTS LIST

Ref. No. 参照番号	Parts No. 部品番号	Description 部品名 / 規格	Re- marks 備考
015	V11-0271-05	1S2076,1S1555	
021 ,22	V11-4100-30	WZ-197	
027 ,28	V11-0271-05	1S2076,1S1555	
029 ,30	V11-5100-10	STV-4H(W)	
031 -34	V11-0273-05	1S2076A	
035 -38	V11-0051-05	1N60	
040	V11-0254-05	YZ-140	
053 -56	V11-0465-05	GP250	
057 ,58	V11-0295-05	W068	
061	V11-0271-05	1S2076,1S1555	
IC1	V30-0192-05	HA1137,-05	
IC2	V30-0155-05	HA1196-01	
IC3	V30-0196-05	HA1197	
IC4	V30-0478-10	UPC78M12H	*
IC5	V30-0405-10	AN6552	
IC6	V30-0409-10	AN6821	
IC7	V30-1005-26	SN74LS90N,F74LS90PC	
IC8	V30-0474-10	LC7258	
IC11,12	V30-0453-10	TA7322P	
Q1	V03-1923-00	2SC1923(R,Q)	
Q2 ,3	V03-0270-05	2SC945(R,Q)	
Q4	V09-0144-60	2SK163(L,M)	TE
Q5 ,6	V03-0270-05	2SC945(R,Q)	
Q7	V09-0144-60	2SK163(L,M)	
Q8 ,9	V03-0270-05	2SC945(R,Q), 2SC2320(E,F)	
Q10	V01-0733-30	2SA733(A)(R,Q),2SA999(E,F)	
Q11 ,12	V03-0270-05	2SC945(R,Q), 2SC2590(E,F)	
Q13	V01-0733-30	2SA733(A)(R,Q),2SA999(E,F)	
Q14 -21	V03-0270-05	2SC945(R,Q), 2SA2320(E,F)	
Q25	V03-0270-05	2SC945(R,Q), 2SC2320(E,F)	TE
Q31 ,32	V01-0979-30	2SA979(F,G,H)	
Q33 -36	V01-0733-30	2SA733(A)(R,Q),2SA999(E,F)	
Q37 ,38	V03-1845-60	2SC1845(1)(E,F)	*
Q39 ,40	V03-1845-10	2SC1845(E,F)	
Q41 ,42	V01-0992-10	2SA992(F,E)	
Q43 ,44	V03-1845-10	2SC1845(E,F)	
Q45 ,46	V03-0270-05	2SC945(R,Q) 2SC2320(E,F)	
Q47 ,48	V03-2590-10	2SC2590(Q,R)	*
Q49 ,50	V01-1110-10	2SA1110(Q,R)	*
Q51 ,52	V01-1102-10	2SA1102(O,Y) 2SB686(R,Q)	
Q53 ,54	V03-2577-10	2SC2577(O,Y) 2SD716(R,Q)	
Q55	V03-2003-00	2SC2003(M,L,K)	
-	W02-0042-05	FRONT END	*K
-	W02-0042-05	FRONT END	TU
-	W02-0042-05	FRONT END	E
-	W02-0043-05	FRONT END	*T
-	W02-0043-05	FRONT END	E
<b>FM FRONT END (W02-004)</b>			
D1	V11-3100-50	1S2236	
IC1	V30-0345-10	SC114	
Q1	V09-0121-10	2SK55	
Q2	V09-0124-20	2SK61	

Ref. No. 参照番号	Parts No. 部品番号	Description 部品名 / 規格	Re- marks 備考
	N30-2006-41	M2 x 6	
	N30-2006-46	M2 x 6	
	N30-3008-46	M3 x 8	
	N87-3008-46	M3 x 8 (Br-Tap)	
	N89-3008-45	M3 x 8 (Bi-Tap) BLK	
	N88-3008-46	M3 x 8 (F-Tap)	
	N91-3010-46	M3 x 10 (TD-Tap)	



**KR-720(L)**

---

---

A product of

**TRIO-KENWOOD CORPORATION**

6-17, 3-chome, Aobadai, Meguro-ku, Tokyo 153, Japan

---

---

**KENWOOD ELECTRONICS, INC.**

1315 E. Watsoncenter Rd. Carson, California 90745, U.S.A.  
75 Seaview Drive, Secaucus, New Jersey 07094, U.S.A.  
1098 North Tower Lane Bensenville, Illinois 60106, U.S.A.

**TRIO-KENWOOD ELECTRONICS, N.V.**

Leuvensesteenweg 504 B-1930 Zaventem, Belgium

**TRIO-KENWOOD ELECTRONICS GmbH**

Rudolf-Braas-Str. 20, 6056 Heusenstamm, West Germany

**TRIO-KENWOOD FRANCE S.A.**

5, Boulevard Ney, 75018 Paris, France

**TRIO-KENWOOD SVENSKA AB**

Kemistvagen 10A, S-183 21 Taby, Sweden

**TRIO-KENWOOD (AUSTRALIA) PTY. LTD.**

30 Whiting St., Artarmon, N.S.W. 2064, Australia

**KENWOOD & LEE ELECTRONICS, LTD.**

Room 501, Wang Kee Building, 5th Floor, 34-37, Connaught Road, Central, Hong Kong